

INSTRUCTION MANUAL

Vibration Meter

VM-83



3-20-41 Higashimotomachi, Kokubunji, Tokyo 185-8533, Japan

<http://www.rion.co.jp/english/>

Organization of this manual

This manual describes the features and operation principles of the vibration meter VM-83. For information regarding the operation of other equipment in the case of incorporating the VM-83 into a measurement system with other equipment, always make sure refer to the documentation of the other equipment.

The page iii and follows contain important information on safety. Be sure to read this part.

This manual contains the following sections.

Outline

Gives basic information on the configuration and features of the unit, and contains a block diagram.

Controls and Features

Briefly identifies and explains all parts of the unit.

Preparations

Describes installation, connections, inserting batteries, pre-use checks and other steps.

Measurement

Describes the steps for measurement.

Comparator

Describes how to use the comparator function.

Printer

Gives information on a printer that can be connected to the unit.

Serial Interface

Describes how to use the serial interface for connection to a computer.

Technical Information

Provides additional information that is helpful for using the unit.

Specifications

Lists the technical specifications of the unit.

Index

Index to the contents of the manual.

- * All company names and product names mentioned in this manual are trademarks or registered trademarks of their respective owners.



The product described in this manual is in conformity with the following European standards;

EN 61000-6-3:2001

EN 61000-6-1:2001

*EN 61000-6-2:2001

Note: CE requirements are met provided that a core filter is fitted to every cable.

* The measurement result may be influenced when the instrument is used in a radio-frequency electromagnetic (RFE) field.

This product can be used in any areas including residential areas.

To conform to the EU requirement of the Directive on Waste Electrical and Electronic Equipment, the symbol mark on the right is shown on the instrument.



This item is classified as “a regulated product or regulated technology in the Foreign Exchange and Foreign Trade Control Act”. Export of this item from Japan requires an export license from the Government of Japan.

FOR SAFETY

In this manual, important safety instructions are specially marked as shown below. To prevent the risk of injury to persons and severe damage to the unit or peripheral equipment, make sure that all instructions are fully understood and observed.



Disregarding instructions printed here incurs the risk of injury to persons and/or damage to peripheral equipment.



Disregarding instructions printed here incurs the risk of damage to the product.

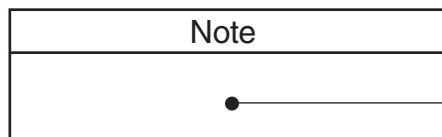

Mentioned about the tips to use this unit properly. (This messages do not have to do with safety.)

Usage Precautions

- Operate the unit only as described in this manual.
- Take care not to drop the unit, and protect it from shocks and vibrations.
- Do not store or use the unit in locations where the unit may be subject to
 - splashes of water or high levels of dust,
 - air with high salt or sulphur content, or other gases or chemicals,
 - high temperature or humidity (50°C or above, 90%RH or above), or direct sunlight,
 - directly transmitted vibrations or shock.
- Observe the following precautions after using the unit:
 - Always switch off the power.
 - When the unit is not to be used for an extended period, remove the batteries to prevent possible damage caused by battery leakage.
- Do not disassemble the unit or attempt internal alterations.
- Have the unit checked and serviced regularly within one or two years. (Sensitivity calibration can be performed at the factory for a fee.)
- When powering the unit externally, use only the specified AC adapter (option). Using a different adapter may cause malfunction or damage.
- Do not tap the LCD panel for example with your finger or a pen, to prevent possible malfunction or damage.
- In case of malfunction, do not attempt any repairs. Note the condition of the unit clearly and contact the supplier.
- When disconnecting cables, always hold the plug and do not pull the cable. Do not apply excessive force.
- When disposing of the unit or the accessories, follow national and local regulations regarding waste disposal.

Contents

FOR SAFETY.....	iii
Outline.....	1
Controls and Features.....	3
Front panel	3
Rear panel	5
Side panel	7
Display	8
Preparations	11
Power supply	11
Inserting batteries	11
AC adapter	12
Using the prop-up feet	13
Selecting an accelerometer	14
Connecting the accelerometer	15
Setting the INPUT SELECT switch.....	17
Accelerometer sensitivity calibration	18
Measurement.....	20
Power-on	20
Measurement mode setting	21
Display characteristics setting	22
High-pass filter setting	23
Low-pass filter setting	24
Level range setting	25
Menu settings	27
Calibration	31
Maximum value hold	33
Peak hold	36
Comparator	38
Printer.....	43

Serial Interface.....	47
Transmission principle	47
Local mode/Remote mode	48
Transfer protocol	50
Error processing	52
Control operation in remote mode	53
Command format	54
Technical Information.....	69
Noise level and measurement range	69
Delay of output signal	73
Rack mounting	73
Accelerometer installation	74
Display range	76
Aliasing effect	77
Filter characteristics	78
VM-83PB1 software	80
Specifications.....	81
Index.....	93

Outline

The VM-83 is a vibration meter designed for measurement and evaluation of vibrations, using a piezoelectric accelerometer or a servo accelerometer. It provides four types of input connectors and allows selection of acceleration, velocity, and displacement measurement. With the optional servo accelerometer, even very low frequency vibrations in the range of 0.1 to 1 Hz can be measured, something that is very hard to achieve with conventional piezoelectric accelerometers.

Display characteristics can be switched to rms, equivalent peak, and equivalent peak-to-peak. Peak hold and max. hold functions are also available, and a comparator with level evaluation output is also available.

AC output, DC output, and a serial interface are provided as standard equipment. The unit uses a box-type design that makes it easily portable, and it can be powered from the AC adapter or from batteries.

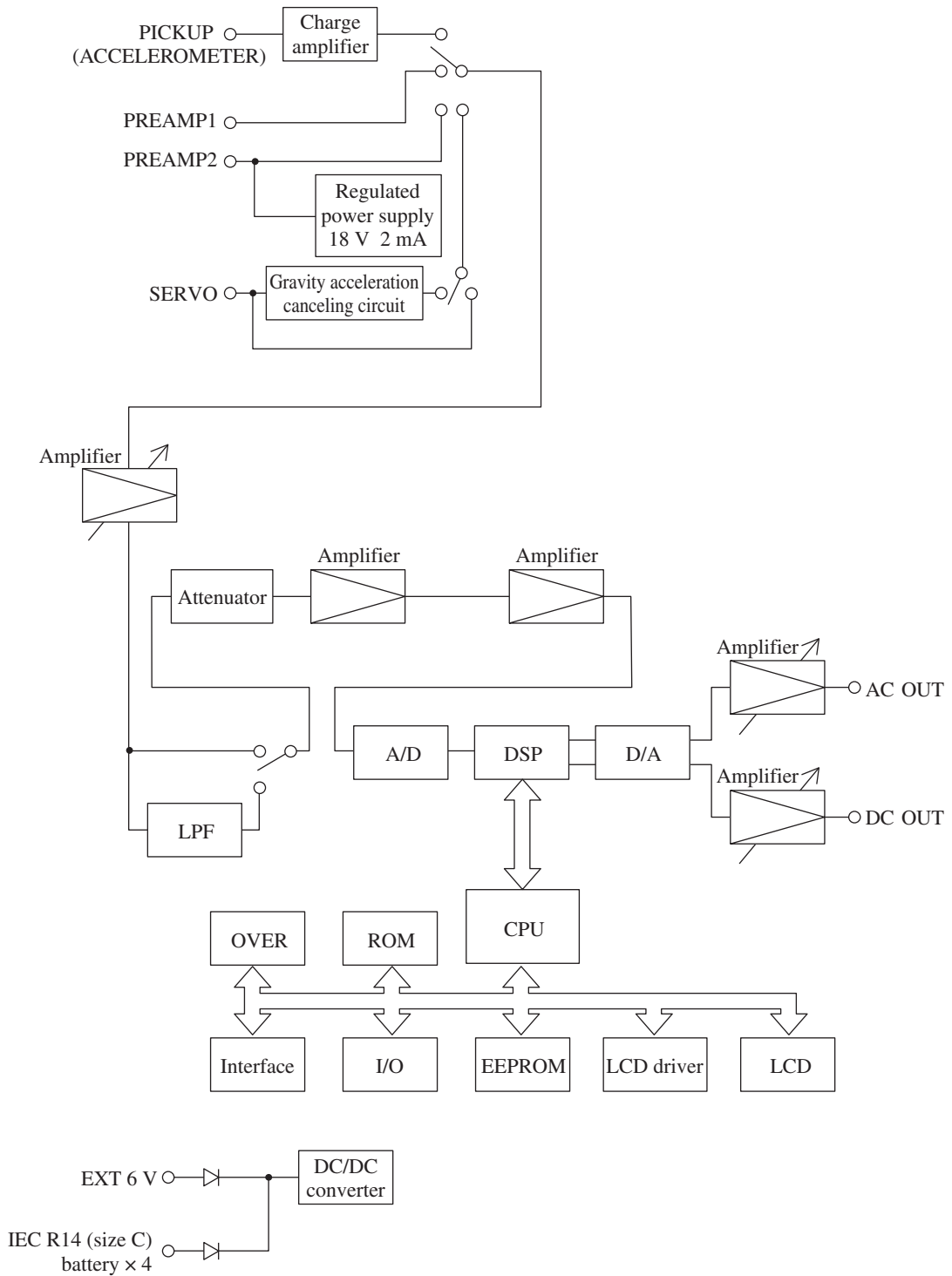

Block diagram

Controls and Features

Front panel

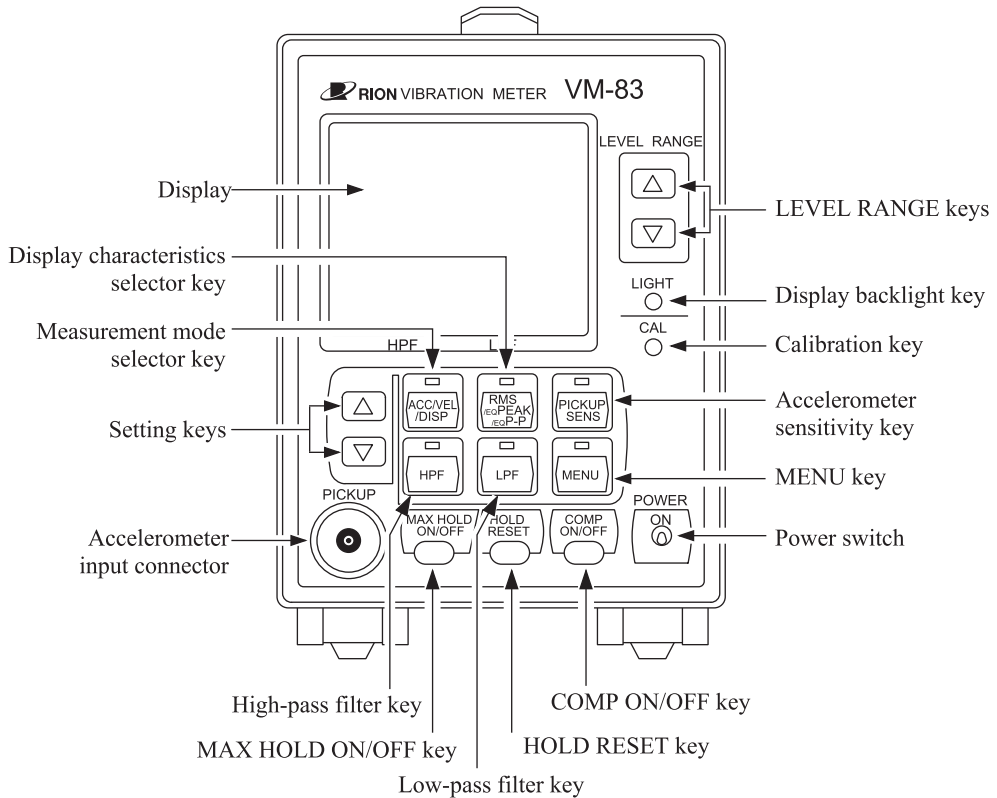

LEVEL RANGE keys

Serve for switching the level range up (Δ) or down (∇).

Display backlight key (LIGHT key)

Serves for turning the display backlight on and off.

When the unit is operating on batteries, the display automatically turns itself off after 60 seconds. When the batteries are run down, the display will be darker.

Calibration key (CAL key)

This key turns the calibration signal supplied at the AC and DC outputs on and off. The signal is used to perform calibration of external equipment.

Accelerometer sensitivity key (PICKUP SENS key)

Serves for setting the accelerometer sensitivity. When the accelerometer sensitivity setting mode is on, the indicator above the key lights.

MENU key

Allows changing the menu by selecting a menu number. If this key is pressed in remote mode, the remote mode is canceled and the unit returns to the local mode.

Power switch

Serves to turn the unit on and off.

COMP ON/OFF key

Serves to turn the comparator function on and off.

HOLD RESET key

Serves for resetting maximum hold data and peak hold data, as well as the comparator output.

Low-pass filter key (LPF key)

Serves for activating the low-pass filter (indicator above the key lights).

MAX HOLD ON/OFF key

Serves to turn the maximum value hold function on and off.

High-pass filter key (HPF key)

Serves for activating the high-pass filter (indicator above the key lights).

Accelerometer input connector (PICKUP connector)

The piezoelectric accelerometer is to be connected here.

Setting keys

Serve to set the measurement mode, display characteristics, low-pass filter, high-pass filter, and accelerometer sensitivity. The keys will affect the function for which the key indicator is lit. The keys are also used for changing menu settings.

Measurement mode selector key (ACC/VEL/DISP key)

Serves to change the measurement mode (indicator above the key lights).

Display characteristics selector key (RMS/EQPEAK/EQP-P key)

Serves to change the display (detection) characteristics (indicator above the key lights).

Display

Shows measurement values and various key settings.

Rear panel

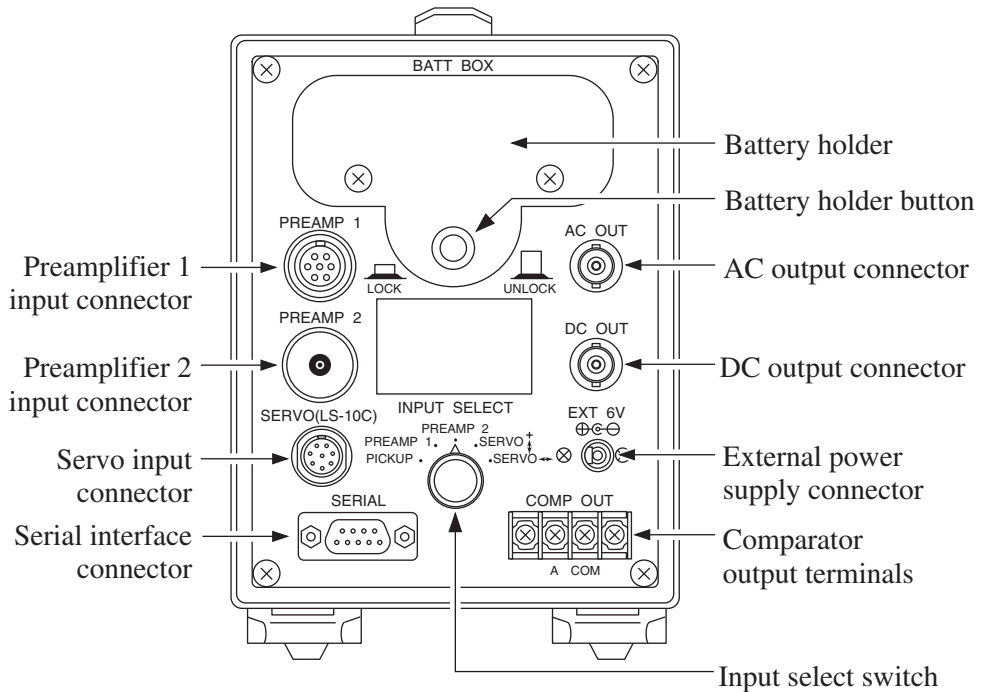

Battery holder

Four IEC R14 (size C) batteries are inserted here.

Battery holder button

Push this button to lock or unlock the battery holder.

AC output connector

An AC signal corresponding to the measurement value is available at this connector (full-scale point: 2 V, output impedance approx. 600 ohms).

DC output connector

A DC signal corresponding to the measurement value is available at this connector (full-scale point: 2 V, output impedance approx. 600 ohms).

External power supply connector

The AC adapter (option) can be connected here.

Comparator output terminals

The comparator signal is available at these terminals. The maximum applied voltage is 24 V, and the maximum drive current varies as follows depending on the applied voltage.

50 mA	(when the applied voltage is 24 V)
25 mA	(when the applied voltage is 12 V)
10 mA	(when the applied voltage is 5 V)

Input select switch

Serves to select the input source. Available settings are PICKUP / PRE-AMP 1 / PREAMP 2 / SERVO \downarrow / SERVO \leftrightarrow .

Serial interface connector

Serves for connection of a computer or printer.

Servo input connector (SERVO connector)

The servo accelerometer (LS-10C or LS-20C) can be connected here.

Preamplifier 2 input connector (PREAMP 2 connector)

A piezoelectric accelerometer with integrated preamplifier can be connected here.

Preamplifier 1 input connector (PREAMP 1 connector)

A piezoelectric accelerometer can be connected here via a preamplifier.

Side panel

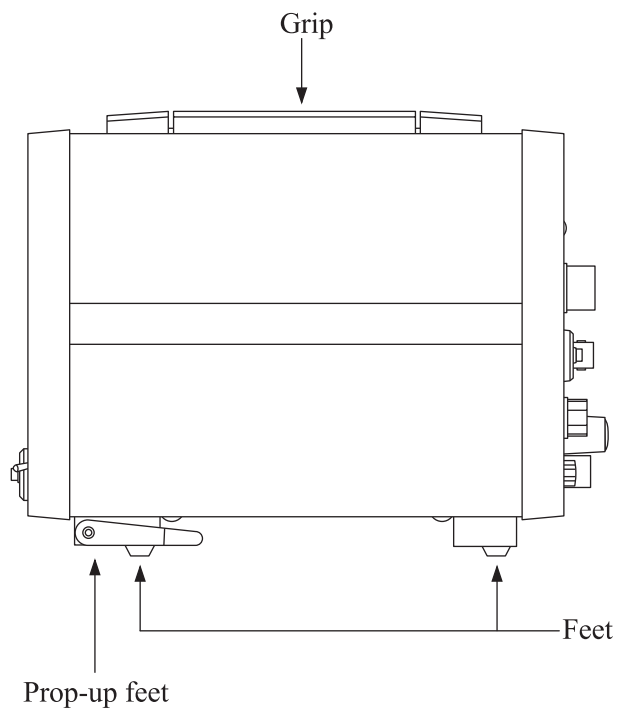

Display

For explanation purposes, the illustration below shows all display elements. In actual use, not all elements will be seen together.

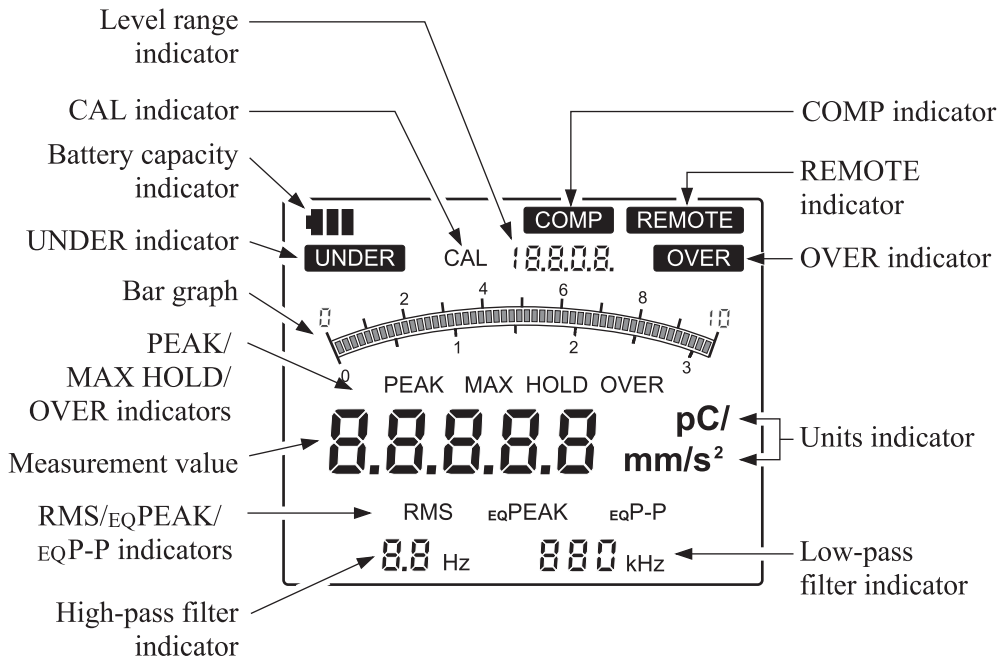

COMP indicator

This indicator appears when the comparator function is selected.

REMOTE indicator

This indicator appears when the unit is being controlled remotely over the serial link.

OVER indicator

This indicator appears when the input signal has caused overload.

Units indicator

The unit applicable to the current measurement mode is shown here.

m/s ²	When a piezoelectric accelerometer is used, this indicator appears during acceleration measurement.
mm/s ²	When a servo accelerometer is used, this indicator appears during acceleration measurement.
mm/s	This indicator appears during velocity measurement.
mm	This indicator appears during displacement measurement.
pC/(m/s ²)	This indicator appears during sensitivity setting for the piezoelectric accelerometer.

Low-pass filter indicator

Shows the low-pass filter setting.

High-pass filter indicator

Shows the high-pass filter setting.

RMS/EQPEAK/EQP-P indicators

Shows the display (detection) characteristics setting.

Measurement value

Shows the current measurement value, maximum hold value, peak hold value, menu settings, etc.

PEAK/MAX HOLD/OVER indicators

When the maximum hold function has been activated, the MAX HOLD indicator is displayed (see page 33).

When the peak hold function has been activated, the PEAK HOLD indicator is displayed (see page 36).

When the hold value has exceeded the measurement maximum, the OVER indicator is displayed.

Bar graph

When the level range setting is 10000, 1000, 100, 10, 1, 0.1, or 0.01, the indication follows the upper scale: 0, 2, 4, 6, 8, 10.

When the level range setting is 3000, 300, 30, 3, 0.3, 0.03, or 0.003, the indication follows the lower scale: 0, 1, 2, 3.

The bar graph indication corresponds to the input level.

UNDER indicator

This indicator appears when the input signal has fallen below the measurement threshold.

Battery capacity indicator

Shows the remaining capacity of the batteries.

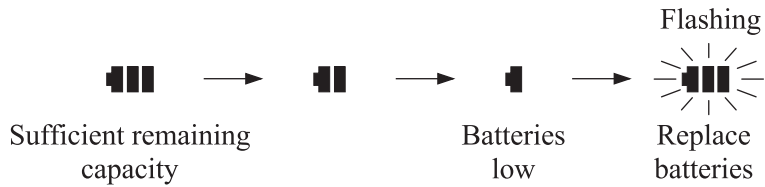

CAL indicator

This indicator appears during calibration.

Level range indicator

Shows which level range has been selected.

Preparations

Power supply

This unit can be operated either on four IEC R14 (size C) batteries or an AC adapter (option).

Inserting batteries

Unlock the battery holder by pressing the battery holder button and pull out the battery holder. After replacing the batteries, push the battery holder back into the unit. Be sure to lock the holder by pressing the battery holder button again.

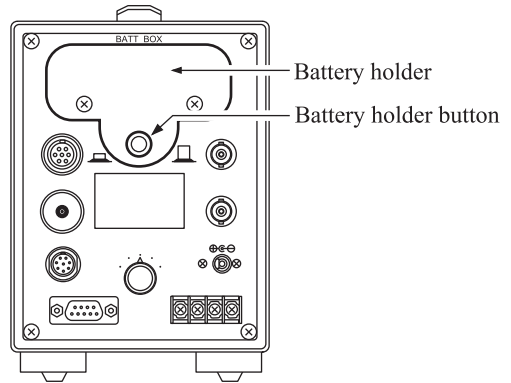

Important

- While inserting or removing batteries, support the battery holder by hand.

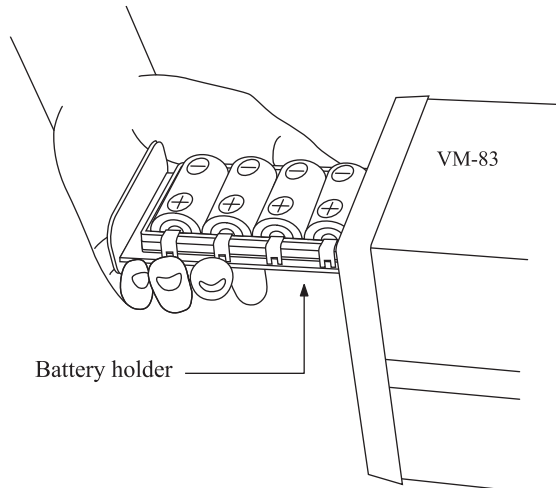

- Take care not to insert batteries with wrong polarity.
- While not using the unit, the batteries should be removed.
- When opening the battery holder, take care that no foreign objects or dirt get deposited in the holder.
- Do not mix old and new batteries, or different types of batteries.

Battery life

Alkaline batteries LR14 approx. 20 hours

Manganese batteries R14P approx. 9 hours

- * The above values were determined under the following conditions.
20°C 50% RH, accelerometer PV-85, ACC, HPF OFF, LPF OFF, backlight OFF, switch LEDs OFF, communications OFF (MENU 0-0), continuous operation
- * The actual battery life will differ, depending on the accelerometer, settings, ambient conditions, and battery type or battery manufactures.

When the backlight is used, battery consumption will be about 20% higher.
When the servo accelerometer is connected, current consumption increases by about 15%.

Remaining battery capacity indication

The following indication appears on the display, depending on the battery status.

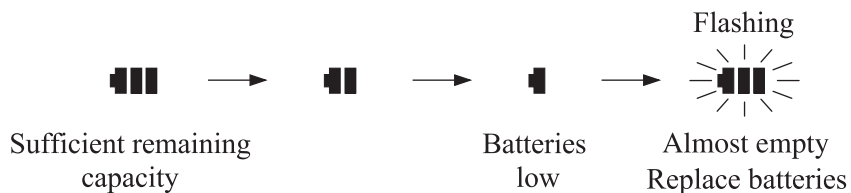

Note

When the battery capacity indicator start to flash, replace the batteries immediately with a fresh set. While the indicator is flashing, the measurement will not be accurate.

AC adapter

The unit can be powered from the following adapter: NC-98C (option)

Connect the cable from the AC adapter to the external power supply connector on the rear panel.

Using the prop-up feet

The unit can be tilted by flipping out the prop-up feet. Tilt the feet until they snap in place.

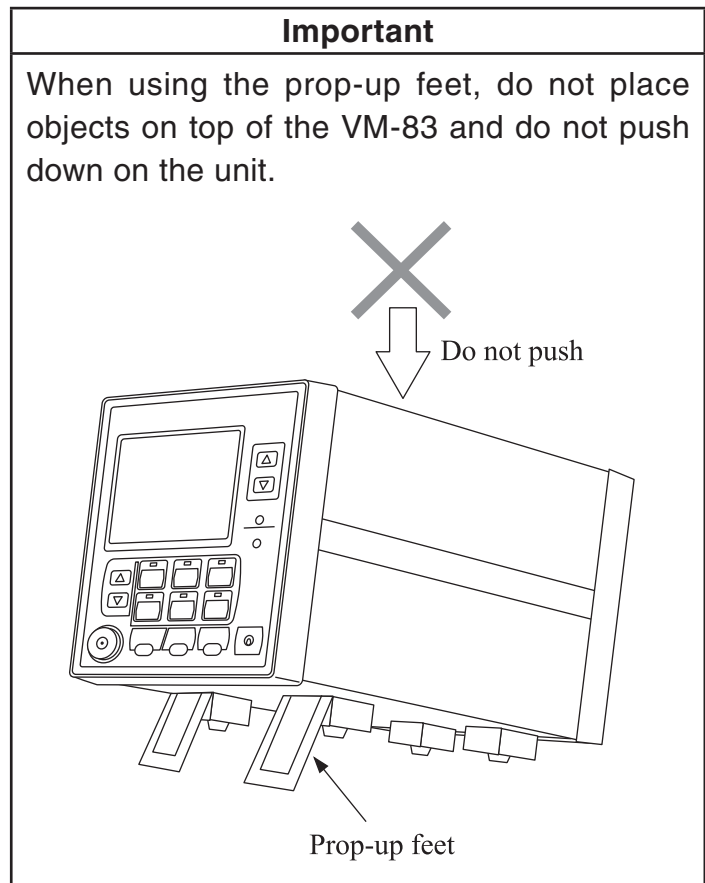

Selecting an accelerometer

The VM-83 can use piezoelectric accelerometer or servo accelerometer. Select the type of accelerometer according to the intended measurement range, vibration frequency range, environmental conditions, and other related factors.

- Some major piezoelectric accelerometers made by Rion (representative values)

	General	High-output	Light weight	Heat-resistant	3-axis
Model	PV-85	PV-87	PV-90B	PV-65	PV-93
Charge sensitivity (pC/(m/s ²))	6	40	0.15	7	0.7
Mounting resonance frequency (kHz) *1	24	9	70	25	30*2
Vibration frequency range (Hz)	1 to 7000	1 to 3000	1 to 25000	1 to 9000	1 to 8000*2
Temperature range (°C)	-50 to +160	-50 to +160	-50 to +160	-50 to +260	-50 to +160
Mass (g)	23	115	1.2	26	28
Construction principle	Shear type	Shear type	Shear type	Shear type	Shear type

*1 When mounted with specified screws at specified torque

*2 Vertical direction value

- Servo accelerometer

The servo accelerometer model that can be used with the VM-83 is the LS-10C or LS-20C.

Model	LS-10C	LS-20C
Voltage sensitivity (V/[m/s ²])	0.300	0.300
Vibration frequency range	DC to 100 Hz	DC to 100 Hz
Temperature range (°C)	-20 to +60	-20 to +60
Mass (g)	220	125

Connecting the accelerometer

Note

Before connecting the accelerometer, turn power to the unit OFF.

Piezoelectric accelerometer

Direct connection

Use the cable supplied with the accelerometer (VP-51 series) to connect the accelerometer to the accelerometer input connector on the VM-83. Because the input circuit is configured as a charge amplifier, accelerometer cable length has almost no effect on sensitivity.

However, a long cable may lead to an increase in internal noise. The cable run should therefore be kept as short as possible.

If the cable length exceeds 5 meters, the use of a preamplifier is recommended.

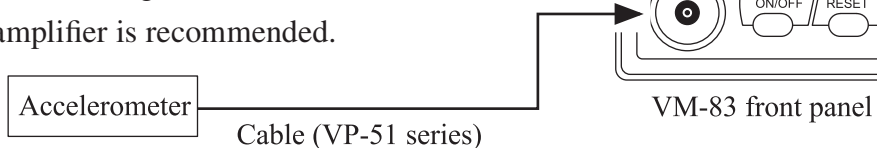

Connection via a preamplifier

When the accelerometer is to be installed at a remote location, a preamplifier should be used to minimize noise and susceptibility to interference.

The preamplifier should be located close to the accelerometer, and the longer cable run should be between the preamplifier and the VM-83.

Use the cable supplied with the accelerometer (VP-51 series) to connect the accelerometer to the input of the preamplifier (VP-26A etc.). Connect the output of the preamplifier to the PREAMP 1 input connector on the VM-83, using a cable of the EC-02S series.

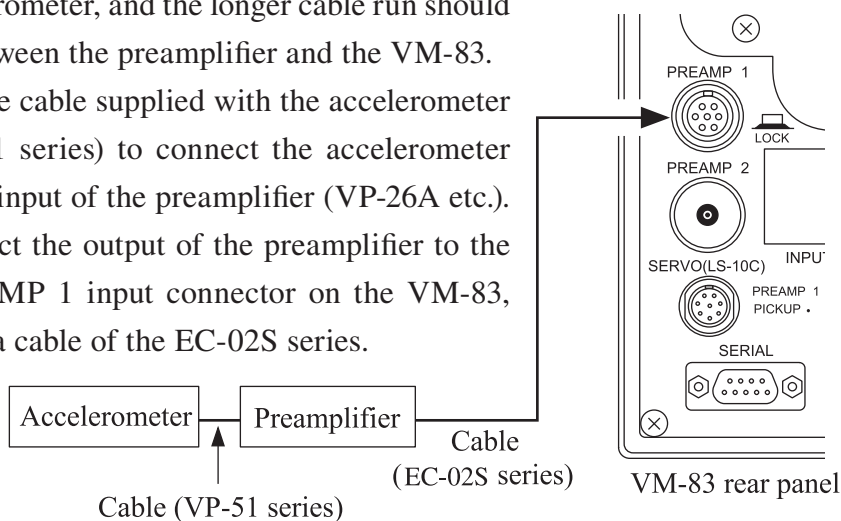

EC-02S series cables are available in four different lengths, as listed below. Choose the cable that is most suitable for your application.

Type	Length
EC-02S	3 m
EC-02SB	10 m

Type	Length
EC-02SD	50 m (with reel)
EC-02SE	100 m (with reel)

Connection of an accelerometer with built-in preamplifier

When using an accelerometer with built-in preamplifier (PV-41, PV-42), use the cable supplied with the accelerometer (VP-51 series) to connect the accelerometer to the PREAMP 2 input connector on the VM-83.

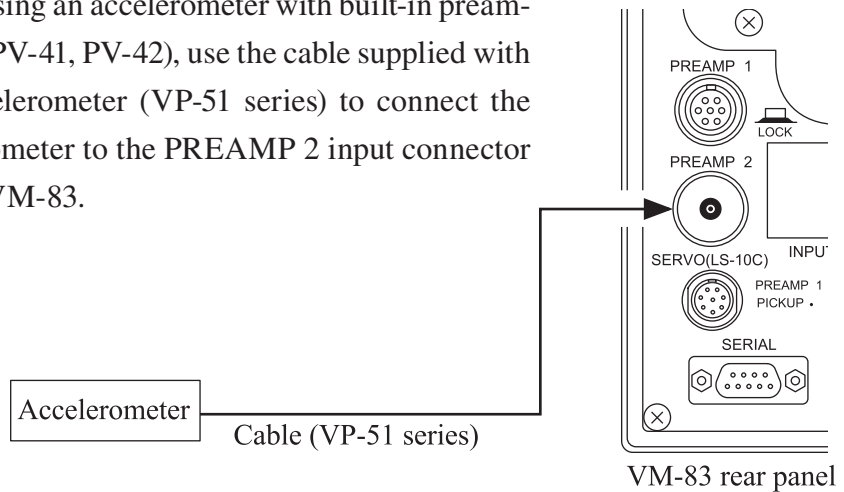

Servo accelerometer LS-10C or LS-20C

Connecting the servo accelerometer LS-10C or LS-20C

Use a cable of the EC-40 series to connect the accelerometer to the SERVO input connector on the VM-83.

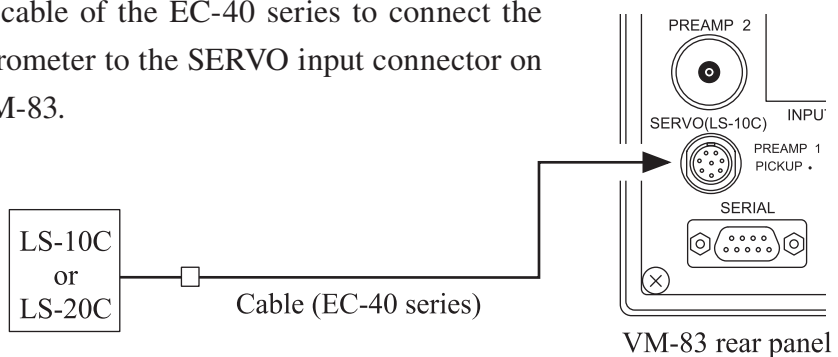

Type	Length
EC-40A	5 m
EC-40B	10 m

Type	Length
EC-40C	30 m (with reel)
EC-40D	50 m (with reel)

Setting the INPUT SELECT switch

Set the INPUT SELECT switch as required for the type of input that is being used.

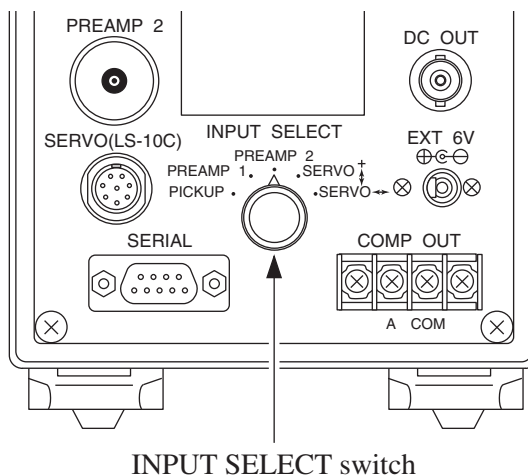

- PICKUP** : Signal from Accelerometer input connector on front panel
- PREAMP1** : Signal from PREAMP 1 connector on rear panel
- PREAMP2** : Signal from PREAMP 2 connector on rear panel
- SERVO** : Signal from SERVO connector on rear panel. Servo accelerometer set to vertical axis.
- SERVO** : Signal from SERVO connector on rear panel. Servo accelerometer set to horizontal axis.

Note

During calibration, comparator operation, maximum hold and peak hold, changing the setting of the INPUT SELECT switch has no effect.

Accelerometer sensitivity calibration

Important

Different accelerometers have different sensitivity. Be sure to perform sensitivity calibration.

Sensitivity calibration

1. Set the INPUT SELECT switch as required.
2. Set the power switch to ON.
3. Press the accelerometer sensitivity key (PICKUP SENS key) on the front panel. (The indicator above the key lights up and the sensitivity value flashes.)

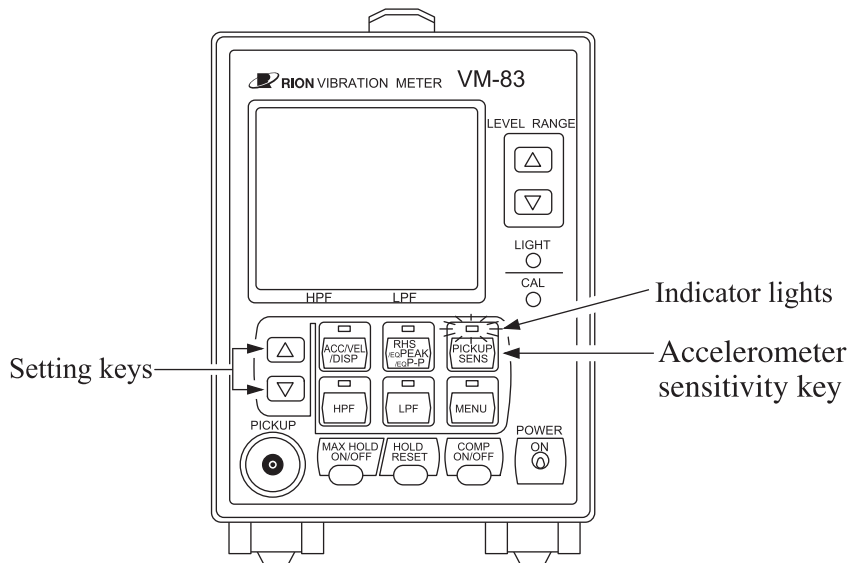

4. Use the setting keys (Δ , ∇) to set the display indication to the value indicated as charge sensitivity on the calibration chart of the accelerometer.

圧電式加速度ピックアップ校正表 Calibration Data	
型式 Model	PV-*
製造番号 Serial No.	*****
電荷感度 (80Hz) Charge Sensitivity	5.90 pC/(m/s ²) ← Charge sensitivity
横感度比 (30Hz) Transverse Sensitivity	** %
静電容量 Capacitance	*** pF
測定温度 Temperature	* °C
測定年月 Date	*
検査責任者 Inspected by	<div style="border: 1px solid black; width: 50px; height: 40px;"></div>
リオン株式会社 RION CO., LTD.	

When an accelerometer with integrated preamplifier is used, enter the voltage sensitivity. For example, when the voltage sensitivity is 5.90 mV/(m/s²), use the value 5.90 pC/(m/s²).

For the servo accelerometer LS-10C or LS-20C, enter the value according to the calibration data (approx. 0.300).

When using the preamplifier VP-26A, set the charge sensitivity.

Holding one of the setting keys down for more than 2 seconds causes the display value to change quickly.

Measurement

Power-on

When the unit is turned on, the same settings as used before the unit was turned off are reestablished (resume function), and measurement starts. The level range, high-pass filter setting, low-pass filter setting, and display characteristics are memorized for each measurement mode.

Settings memorized by resume function	Settings reset at regular vibration measurement start*
Measurement mode	CAL status
Level range	Maximum value hold
Display characteristics	Peak hold
High-pass filter	Backlight status
Low-pass filter	Sensitivity setting status
Sensitivity	MENU setting status
MENU0 to MENU2 item settings	Comparator status
MENU4 to MENU8 item settings	Remote status

- * These measurement conditions are not memorized by the resume function. They will be reset to the default vibration measurement condition when the unit is turned on.

Note
Settings made via the serial interface are not memorized for the resume function.

Measurement mode setting

Select the measurement mode from ACC (acceleration), VEL (velocity), or DISP (displacement).

Setting procedure

1. Press the ACC/VEL/DISP key. (The indicator above the key lights up.)

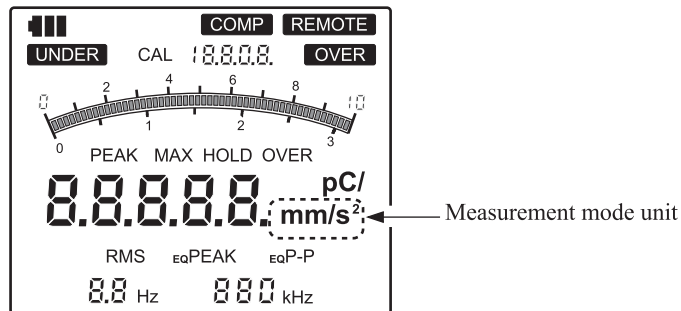

2. Use the setting keys (Δ , ∇) to select from ACC \rightarrow VEL \rightarrow DISP.
 - ACC (acceleration) : m/s^2 , mm/s^2
 - VEL (velocity) : mm/s
 - DISP (displacement) : mm

Note

The unit for acceleration (ACC) measurement depends on the setting of the INPUT SELECT switch.

PICKUP, PREAMP 1, PREAMP 2 : m/s^2

SERVO \downarrow , SERVO \leftrightarrow : mm/s^2

Display characteristics setting

Select the display (detection) characteristics from RMS, EQPEAK, or EQP-P.

Setting procedure

1. Press the RMS/EQPEAK/EQP-P key. (The indicator above the key lights up.)

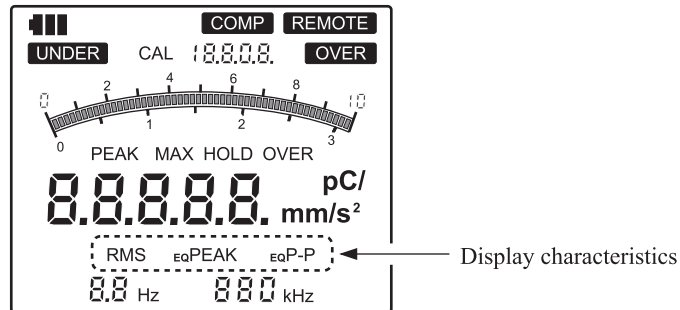

2. Use the setting keys (Δ , ∇) to select from RMS \rightarrow EQPEAK \rightarrow EQP-P.

- RMS : Effective value
- EQPEAK : Equivalent peak value
- EQP-P : Equivalent peak-to-peak value

The equivalent peak value and equivalent peak-to-peak value are calculated according to the following formula.

$$\text{Equivalent peak value} = \text{rms} \times \sqrt{2}$$

$$\text{Equivalent peak-to-peak value} = \text{equivalent peak value} \times 2$$

High-pass filter setting

Setting procedure

1. Press the HPF key. (The indicator above the key lights up.)

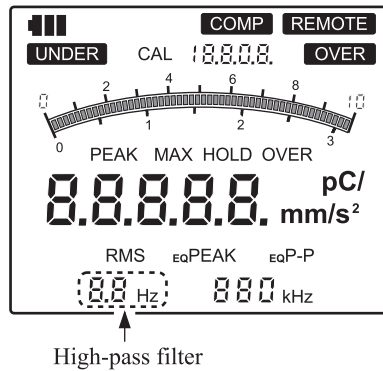

2. Use the setting key (Δ , ∇) to select the filter setting. The available settings are listed below.

Piezoelectric accelerometer

1 Hz, 3 Hz, 10 Hz, 20 Hz, 50 Hz, -- (OFF; ACC only)

Servo accelerometer

0.1 Hz, 0.3 Hz, 1 Hz

For more information on the characteristics of the high-pass filter, please refer to the Technical Information (see page 78 and 79).

Low-pass filter setting

Setting procedure

1. Press the LPF key. (The indicator above the key lights up.)

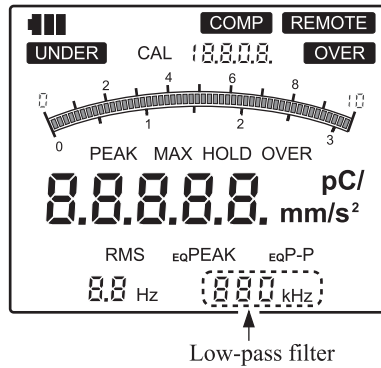

2. Use the setting keys (Δ , ∇) to select the filter setting. The available settings are listed below.

Piezoelectric accelerometer

100 Hz, 300 Hz, 1 kHz, 3 kHz, 10 kHz, -- (OFF; ACC only)

Servo accelerometer

50 Hz, 100 Hz

For more information on the characteristics of the low-pass filter, please refer to the Technical Information (see page 78 and 79).

Level range setting

Set the level range as follows.

Use the LEVEL RANGE keys (Δ , ∇) to select an appropriate level range.

The relationship between INPUT SELECT switch, accelerometer sensitivity, measurement mode, and HPF is shown in the table on the next page.

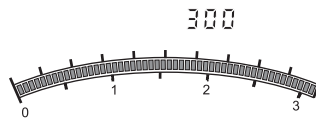
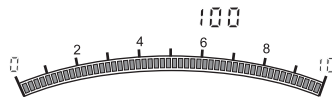

- When INPUT SELECT switch is set to PICKUP, PREAMP 1, or PREAMP 2

(*0 HPF: 1 Hz; *1 HPF: 3 Hz; *2 HPF: 10 Hz or above)

Sensitivity	Measurement mode	Level range							
0.030 to 0.999 pC/(m/s ²)	ACC	3	10	30	100	300	1000	3000	10000
	VEL	30	100	300	1000	3000	10000	-	-
	DISP*0	-	10	30	100	300	1000	3000	10000
	DISP*1	3	10	30	100	300	1000	3000	10000
	DISP*2	0.3	1	3	10	30	100	300	1000
1.00 to 9.99 pC/(m/s ²)	ACC	0.3	1	3	10	30	100	300	1000
	VEL	3	10	30	100	300	1000	-	-
	DISP*0	-	1	3	10	30	100	300	1000
	DISP*1	0.3	1	3	10	30	100	300	1000
	DISP*2	0.03	0.1	0.3	1	3	10	30	100
10.0 to 99.9 pC/(m/s ²)	ACC	0.03	0.1	0.3	1	3	10	30	100
	VEL	0.3	1	3	10	30	100	-	-
	DISP*0	-	0.1	0.3	1	3	10	30	100
	DISP*1	0.03	0.1	0.3	1	3	10	30	100
	DISP*2	0.003	0.01	0.03	0.1	0.3	1	3	10

- When INPUT SELECT switch is set to SERVO ↕ or SERVO ↔

Sensitivity	Measurement mode	Level range				
0.100 to 0.999	ACC	10	30	100	300	1000
	VEL	1	3	10	30	100
	DISP	0.1	0.3	1	3	10

Menu settings

The settings for the serial interface, printer, peak hold function, and comparator function are made via menus.

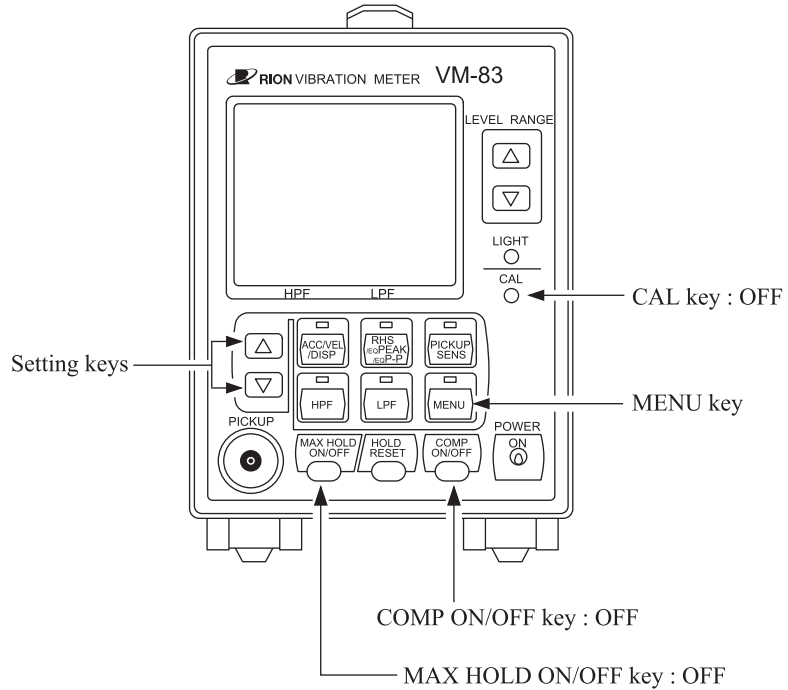

1. Call up the menu screen.

Note

If one of the keys CAL, COMP ON/OFF, or MAX HOLD ON/OFF is set to ON, the menu screen will not appear.

2. When the MENU key is pressed, a menu screen as shown below appears.

With each push of the MENU key, the menu number cycles through 0 → 1 → 2 → 3 → 4 → 5 → 6 → 7 → 8 → measurement screen.

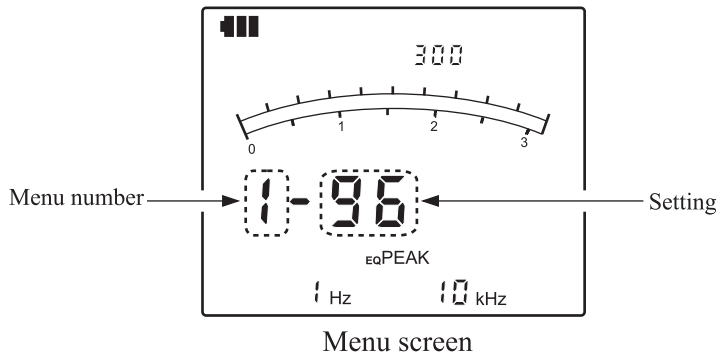

3. Select the number of the desired menu, and use the setting key (Δ , ∇) to change the displayed value.

Note
The new setting will become effective when switching back from the menu screen to the measurement screen.

Menu contents

Menu 0

Serial interface and printer function ON/OFF

- 0-0 Serial interface and printer function OFF. Choose this setting when using neither the serial interface nor the printer function.
- 0-1 Serial interface ON
- 0-2 Printer function ON

Menu 1

Serial interface and printer transfer rate

- 1-96 Transfer rate 9600 bps
When the printer function is set to ON, select the 1-96 setting.
- 1-19 Transfer rate 19200 bps

Menu 2

Serial interface ID number

2- * * Choose a setting from 0 to 15.

Menu 3

Peak hold function ON/OFF

3-0 Peak hold function OFF

3-1 Peak hold function ON

Menu 4

Comparator function and comparator level

Sets the comparator function and chooses a level between 0 and 98% of the full-scale value, in 2% steps

4- * * Choose a setting from 0 to 98 in steps of 2.

Menu 5

Delay time for comparator function

Sets the delay time in the range from 0 to 9 seconds

5- * Choose a setting from 0 to 9 in steps of 1.

Menu 6

Comparator function auto reset ON/OFF

6-0 Auto reset function OFF

6-1 Auto reset function ON

Menu 7

Auto reset time for comparator function

When auto reset has been set to ON with menu 6, this setting determines the auto reset time in the range from 0 to 90 seconds, in 1 second steps

7- * * Choose a setting from 0 to 90 in steps of 1.

Menu 8

Comparator output buzzer

This controls buzzer use for the comparator function. When enabled, the buzzer sounds while the comparator output is active. When disabled, there is no buzzer sound also when the comparator output is active.

8-0 Buzzer disabled

8-1 Buzzer enabled

Note
The settings for menu number 0 to 2, and 4 to 8 will be retained also while the unit is turned off.

Menu number	Setting	
0	0-0	Serial interface and printer OFF
	0-1	Serial interface ON
	0-2	Printer ON
1	1-96	9600 bps
	1-19	19200 bps
2	2- * *	ID number setting 0 to 15
3	3-0	Peak hold OFF
	3-1	Peak hold ON
4	4- * *	Comparator level setting 0 to 98 (in 2 steps)
5	5- *	Delay time setting 0 to 9
6	6-0	Auto reset OFF
	6-1	Auto reset ON
7	7- * *	Auto reset time setting 0 to 90
8	8-0	Buzzer disabled
	8-1	Buzzer enabled

Calibration

When using external equipment to record the AC output signal or DC output signal of the VM-83, perform calibration as follows.

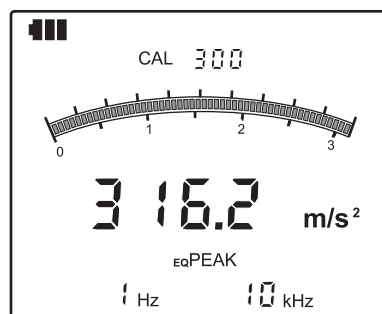
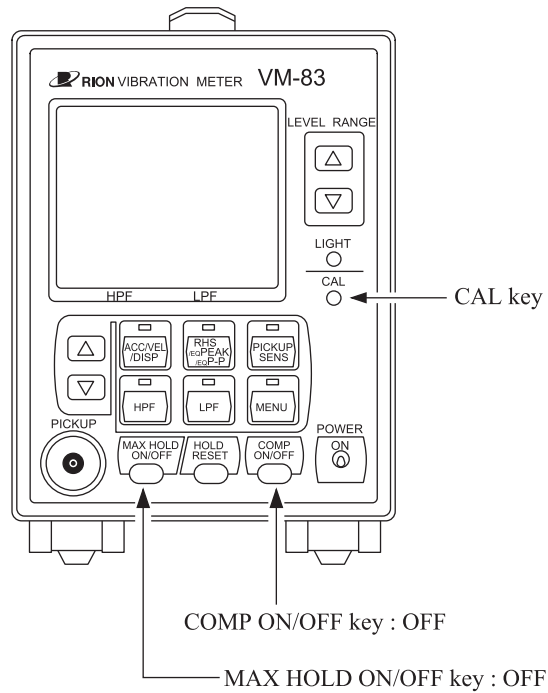

In the CAL (calibration) state, the range full-scale signal is output from the AC output connector and DC output connector.

- (1) When INPUT SELECT switch on rear panel is set to PICKUP, PRE-AMP 1, or PREAMP 2

AC output connector (AC OUT) : 80 Hz, 2 V*

DC output connector (DC OUT) : 2 V

- (2) When INPUT SELECT switch on rear panel is set to SERVO \updownarrow or SERVO \leftrightarrow

AC output connector (AC OUT) : 1 Hz, 2 V *

DC output connector (DC OUT) : 2 V

Pressing the CAL key again turns the calibration mode off.

- * AC output signal in calibration mode

Display characteristics RMS : 2 V_{rms} output

EQPEAK : 2 V_{peak} output

EQP-P : 2 V_{p-p} output

Note	
In calibration mode, all controls except the LIGHT key, CAL key, and power switch are inactive.	
To enable correct output of the calibration signal when the CAL key is pressed, the following settings are required.	
- COMP ON/OFF	: OFF
- MAX HOLD ON/OFF	: OFF
- Menu 3, Peak hold ON/OFF	: OFF
When the range setting is 0.03, 0.3, 3, 30, 300, or 3000, the range full-scale value is 0.0316, 0.3162, 3.162, 31.62, 316.2, or 3162, respectively.	

Maximum value hold

This function serves for holding the maximum measured value.

Setting procedure

1. Press the MAX HOLD ON/OFF key to set the function to ON.

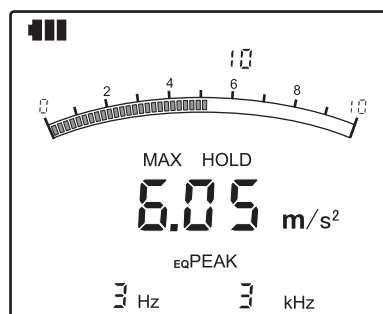
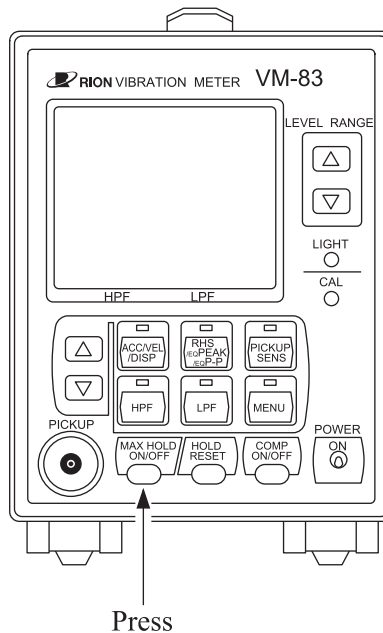

2. When the maximum hold function is ON, the indication MAX HOLD appears on the display, and the indicated numeric value is the maximum value measured up to that point. When a higher value occurs, the display is updated.

- When the maximum hold value is higher than the overload threshold, the indication MAX HOLD OVER is shown.

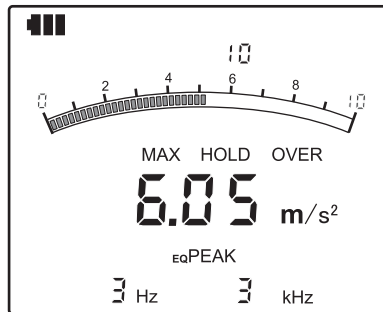

- The HOLD RESET key can be used to reset the maximum hold value at any time.

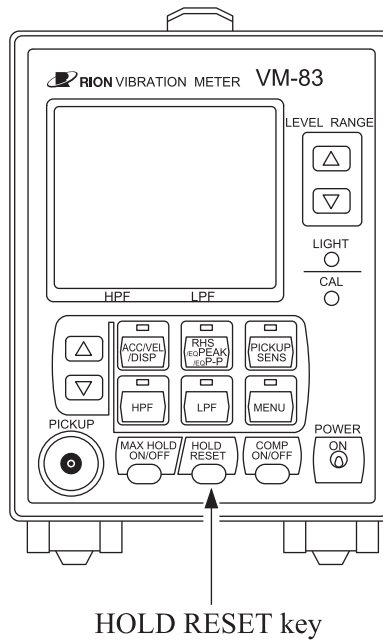

5. Pressing the MAX HOLD key again turns the maximum hold mode off. The unit returns to normal measurement.

Note

While the maximum hold function is ON, all controls except the LIGHT key, MAX HOLD ON/OFF key, HOLD RESET key, and power switch are inactive.

The maximum hold function applies only to the numeric display. The bar graph indication continues to function as during normal measurement.

Peak hold

The peak hold function uses 51.2 kHz sampling on the vibration input signal to determine the peak value.

Setting procedure

1. Use the MENU key to call up menu 3.
2. Use the setting keys to select the setting 3-1 (peak hold ON).

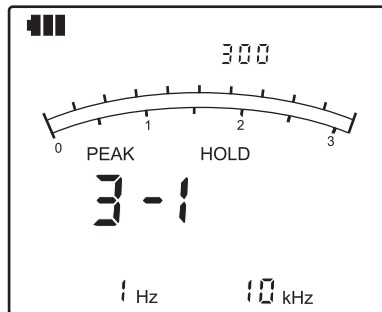

Menu 3 screen

3. Return to the measurement screen.
4. When the peak hold function has been activated, the indication PEAK HOLD appears on the display, and the indicated numeric value is the peak value measured up to that point. When a higher peak occurs, the display is updated.
When the peak hold value is higher than the overload threshold, the indication PEAK HOLD OVER is shown.



5. The HOLD RESET key can be used to reset the peak hold value at any time.

Note

The peak hold function applies only to the numeric display. The bar graph indication continues to function as during normal measurement.
--

While the peak hold function is ON, all controls except the LIGHT key, MENU key, HOLD RESET key, and power switch are inactive.

Turning the peak hold function off

Set the menu 3 item to 3-0.

Note

The peak hold function is available only for ACC (acceleration) measurement.
--

The bar graph continues to operate with the display characteristics (acceleration) as selected before activating peak hold.

Comparator

Comparator operation

The comparator works by constantly monitoring the measured vibration level and comparing it to a preset reference level (comparator level). If the comparator level is exceeded, the comparator output becomes active (open collector circuit, LCD flashing, buzzer sounds).

To turn the comparator function on and off, use the COMP ON/OFF key. Pressing the COMP ON/OFF key once turns the function on and pressing it once more turns it off again.

The various settings for the comparator function are made via menu screens (see “Menu Settings” on page 27).

Setting items

- Comparator level 0 to 98% in 2% steps
- Delay time 0 to 9 seconds in 1 s steps
- Auto reset function
- Auto reset time 0 to 90 seconds in 1 s steps
- Buzzer

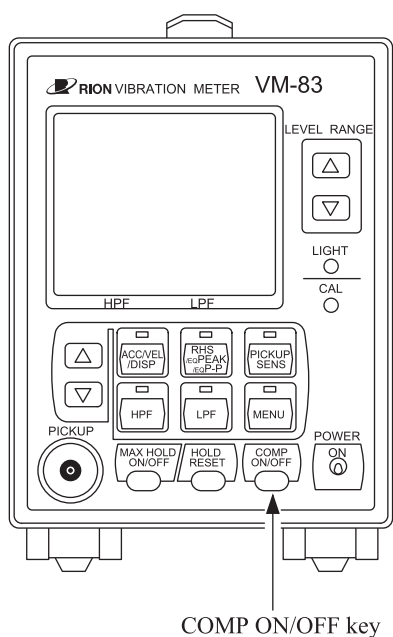

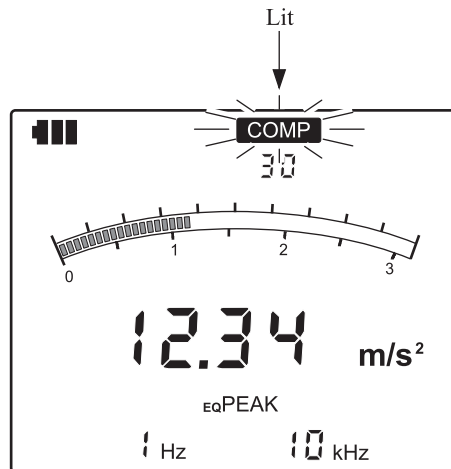

While comparator function is operating, the COMP indicator is shown. In the bar graph indication, the bar corresponding to the comparator reference level remains constantly on.

Comparator level

The comparator level is the threshold where the comparator output becomes active. This setting is made with menu 4. (See “Menu settings” on page 27.)

For example, if the comparator level is set to 48%, the level corresponding to 48% of the level scale value is the threshold, and the 48% point of the bar graph scale is on.

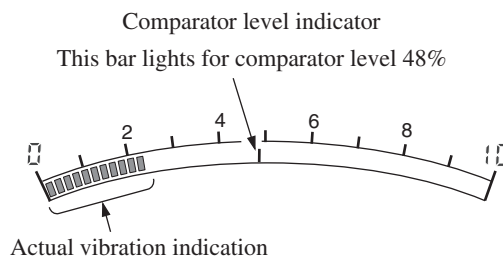

Note

While the comparator function is ON, all controls except the LIGHT key, HOLD RESET key, COMP ON/OFF key, and power switch are inactive.

Auto reset function

The auto reset function is controlled with menu screen 6 (see “Menu Settings” on page 27).

When the function is set to ON and the vibration level has fallen again below the comparator level, the comparator output will automatically be reset (turned off) after the auto reset time has elapsed. When the function is set to OFF, the comparator output remains on until the HOLD RESET key is pressed or the comparator function is turned off with the COMP ON/OFF key.

Auto reset time

The auto reset time is set with menu screen 7 (see “Menu Settings” on page 27).

When the function is set to ON and the vibration level falls below the comparator level, the comparator output will be reset after this time.

The auto reset time can be set from 0 to 90 seconds in 1 second intervals.

This setting is used when the auto reset function has been set to ON.

Buzzer

This setting controls operation of the buzzer when the comparator is activated.

The setting is made with menu screen 8 (see “Menu Settings” on page 27).

Operation

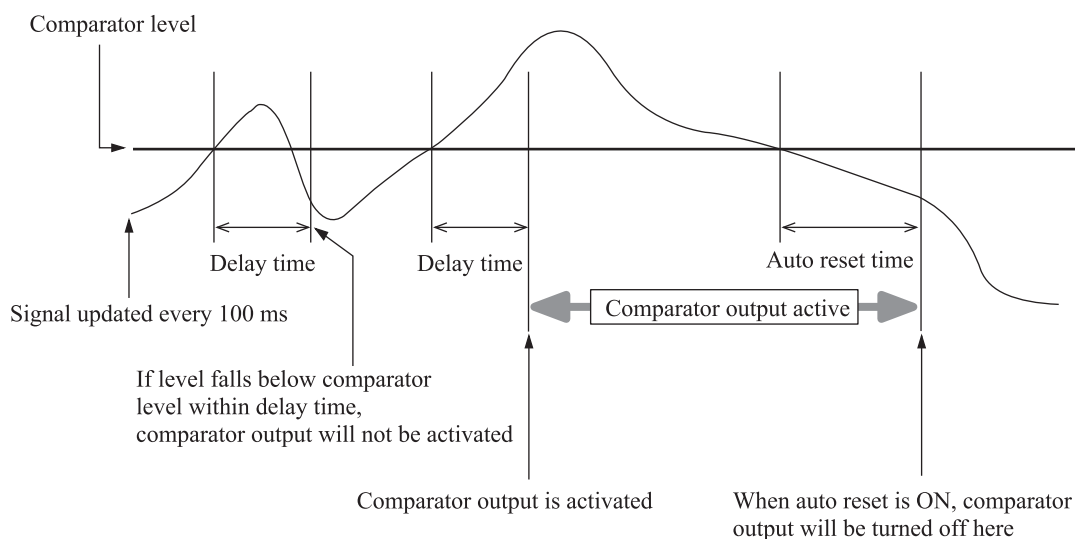

Reset operation

When the comparator output was activated, it can be reset in three ways.

(1) Auto reset

As described above, when auto reset is ON, the comparator output will be turned off automatically after activation when the auto reset time has elapsed.

(2) HOLD RESET key

Pressing the HOLD RESET key on the front panel immediately resets the comparator output. This function is independent of the auto reset ON/OFF setting.

(3) COMP ON/OFF key

Turning the comparator function off by pressing the COMP ON/OFF key on the front panel immediately resets the comparator output.

With methods (1) and (2), the comparator function remains ON also after reset. With method (3), the unit returns to normal measurement.

Comparator output

The comparator output has three elements.

- (1) Buzzer is heard (long intermittent beeps). This applies only if the buzzer function has been set to ON with menu 8.
- (2) LCD display flashes.
Measurement value indicator section flashes in 0.5 second intervals.
- (3) Open collector circuit operates, causing the comparator output terminals on the rear panel to close.

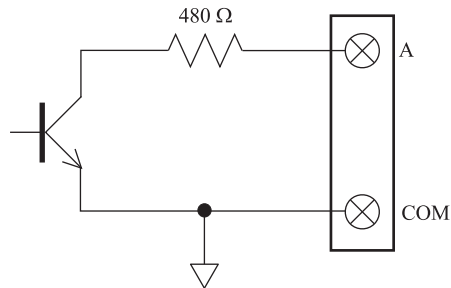

Circuit block diagram

Maximum drive current: 50 mA (when applied voltage is 24 V)
25 mA (when applied voltage is 12 V)
10 mA (when applied voltage is 5 V)
Maximum applied voltage: 24 V

Printer

You can connect an optional printer to produce hard copy of measurement results. The following printers are compatible with the VM-83:

CP-10, CP-11, DPU-414

Activating printer operation

1. Turn power to the VM-83 and the printer off.
2. Use a generic cable to connect the serial interface connector on the rear panel of the VM-83 to the printer.

Cable: Straight serial cable (generic)

Connector type on VM-83: 9-pin D-sub, male

Connector type at printer: 25-pin D-sub, female (For DPU- 414, use the connector adapter supplied with the printer.)

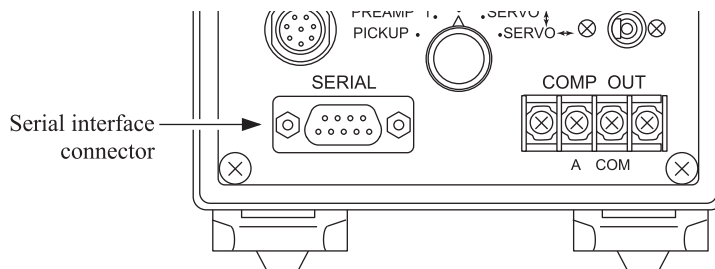

3. Set the DIP switches on the printer as required, then turn on the printer and set it to ON LINE.
4. Set the power switch of the VM-83 to ON.
5. Using the menu screens, select the menu settings 0-2 and 1-96. When you switch back from the menu screen to the measurement screen, printing starts.

Stopping printer operation

1. Using the menu screens, select the menu setting 0-0.
2. Disconnect the cable.

Note

Printer operation is paused during calibration, comparator operation, sensitivity setting, and while using the menu screens.

DIP switch settings for printers CP-11, CP-10

Set the DIP switches for the respective printers as shown below.

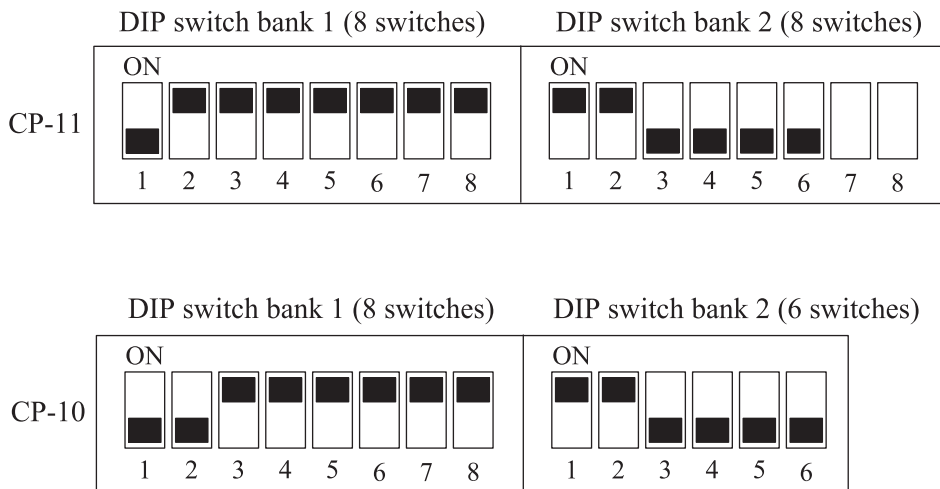

Note

Switches 7 and 8 of DIP switch bank 2 of printer CP-11 are set individually at the factory before shipping.

DIP switch settings for printer DPU-414

When connecting the printer DPU-414, set the DIP switches 1 to 3 for the printer software as follows. For more information on making these settings, please refer to the instruction manual of the DPU-414.

Vibration meter VM-83 (9600 bps)

SW-1	1	OFF
	2	ON
	3	ON
	4	OFF
	5	ON
	6	OFF
	7	ON
	8	ON
SW-2	1	ON
	2	ON
	3	ON
	4	ON
	5	ON
	6	ON
	7	ON
	8	ON
SW-3	1	ON
	2	ON
	3	OFF
	4	ON
	5	OFF
	6	ON
	7	ON
	8	ON

Printout sample

ACC HPF	m/ss 1 Hz	RMS LPF	FS 3 kHz	1000 *=OV	#=UN
24	31	30	16		2#
2#	127	1006 *	739		311
216	348	636	838		878 *
692	298	517	389		174
96	72	85	356		587
712 *	722	268	298		833 *
557	206	82	97		236
498	454	200	157		150

A set of five measurement values for every 2 seconds is printed out every 10 seconds as one line.

“*“ is used to indicate an OVER occurrence and “#” an UNDER occurrence.

Serial Interface

The VM-83 incorporates a serial interface that can be used to set measurement parameters and control measurement using commands sent from a computer. Measurement results can also be sent to the computer.

Transmission principle

Transfer principle	:	asynchronous, half-duplex
Data word length	:	8 bit
Stop bits	:	2
Parity	:	none
Baud rate	:	9600 bps, 19200 bps
Cable type	:	Generic cross-wired serial cable (null modem) Connector on VM-83 9-pin D-sub, male

Local mode/Remote mode

- Local mode

In this mode, the controls on the panel of the VM-83 are used to operate the unit.

Immediately after being turned on, the unit is always in local mode.

- Remote mode

In this mode, the VM-83 operates in response to commands sent from a computer. Only the MENU key and LIGHT key on the VM-83 are active, all other controls are disabled. The indication REMOTE appears on the display of the VM-83 when the unit is in remote mode.

- Switching between local mode and remote mode

The RMT command is used to switch between local mode and remote mode.

Preparations

1. Turn power to the VM-83 and the computer off.
2. Use a generic cable to connect the serial interface connector on the rear panel of the VM-83 to the computer.

Cable : Generic cross-wired serial cable
(null modem)

Connector type on VM-83 : 9-pin D-sub, male

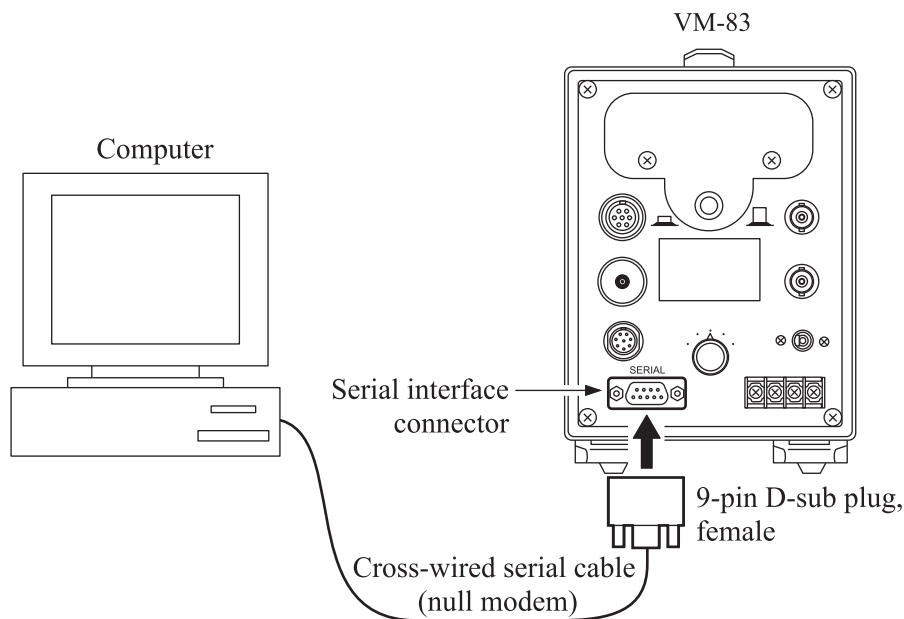

3. Set the power switch of the VM-83 to ON.
4. Make the required menu settings at the VM-83.
For details, please refer to “Menu Settings” on page 27.

Menu 0-1

Menu 1-96 or 1-19 Set transfer rate.

Menu 2- * * Set ID number.

Transfer protocol

Sending of commands

In order to control the VM-83 from a computer or to retrieve measurement data, certain commands must be sent to the VM-83. The data exchange must be performed according to certain rules, to ensure that both the VM-83 and the computer recognize the commands and data properly.

To send commands to the VM-83, the following procedure must be observed.

The following explanation assumes that the preparations described on page 49 have been completed.

* * stands for the ID number.

Example : If the ID number 0 is set, * * stands for 00.

1. The computer sends `RMT1 * * <CR><LF>` to the VM-83.
2. When `RMT1 * * <CR><LF>` has been received, the VM-83 returns `<ACK>READY<CR><LF>` to the computer. The link is now established, and the indication REMOTE appears on the display of the VM-83.
3. To change a setting at the VM-83, the computer sends (setting command) `<CR><LF>` to the VM-83.
4. When a valid setting command is received by the VM-83, it carries out the respective processing steps. When these are completed successfully, the VM-83 returns an `<ACK>READY<CR><LF>` to the computer.
5. To receive data, the computer sends (data request command) `<CR><LF>` to the VM-83.
6. When the VM-83 receives a command which requests data, it carries out the respective processing steps and sends (data) `<EOT><CR><LF>` to the computer.
7. To terminate the link, the computer sends `RMT0 * * <CR><LF>` to the VM-83.

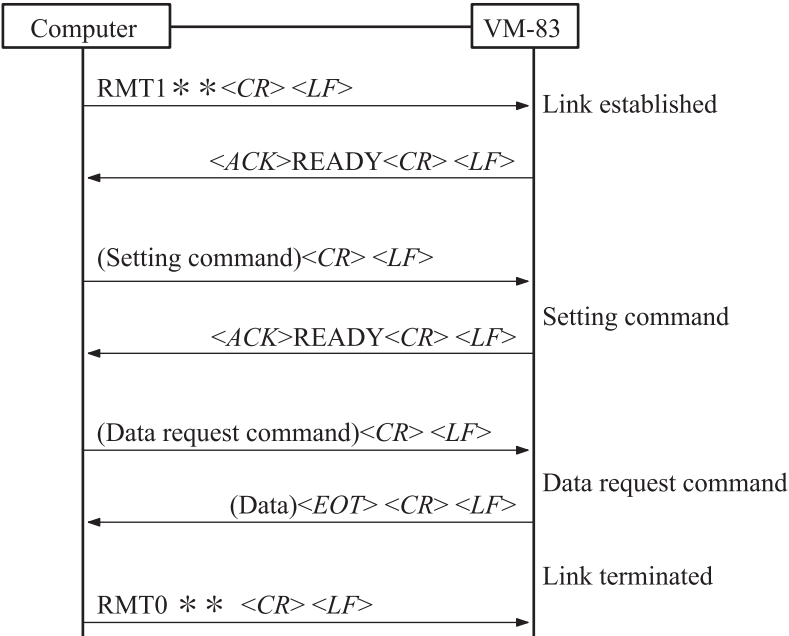

** is the ID number.

- <ACK> : Control code 06H (acknowledge)
- <CR> : Control code 0DH (carriage return)
- <LF> : Control code 0AH (line feed)
- <EOT> : Control code 04H (end of transfer)
- READY : ASCII string
- (command) : ASCII string (command and parameters)
- (data) : ASCII string (data requested by command)

Error processing

In order to ensure correct data exchange between the VM-83 and the computer, the rules described above must be observed. If an error occurs, the following steps should be taken.

The computer has sent `RMT1 * * <CR><LF>` but the REMOTE indicator on the VM-83 does not light:

Send `RMT1 * * <CR><LF>` again after about 4 seconds. Repeat this 2 to 3 times. If the REMOTE indicator still does not light, one of the following conditions may exist.

- Transfer parameters do not match. (Check settings made with menu screens.)
- Interface cable is defective or not properly connected.
- VM-83 is not powered.
- ID number setting does not match.

When the computer has sent a wrong command or the parameter is out of range, the VM-83 disregards that command. If the VM-83 is in receiving mode but there is no command from the computer for 4 seconds or more, the receive mode times out.

Control operation in remote mode

While the VM-83 is in remote mode, only the LIGHT key and MENU key are active. The LIGHT key allows turning the display backlight on and off, and the MENU key in remote mode serves for switching back to local mode. This allows manual override of remote mode at any time.

Command format

Commands that can be used by the VM-83 consist of 3 characters (3 bytes), usually followed by a parameter which specifies the action range of the command.

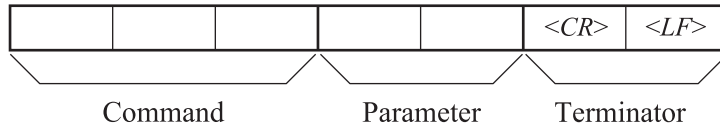

There are two types of parameters:

- Parameters for changing function settings
- Parameter for requesting data

The parameters for changing function settings are numerals, and the parameter for requesting data is “?”. In the following command description, the function setting parameters are denoted by “n”. The data output by the VM-83 in response to the data requesting command are denoted by “p”.

Note
The VM-83 cannot process multiple commands sent together.

Command list

Command	Function	See page
RMT n1 n2 n3	Select local mode/remote mode	56
RMT?	Get ID number and remote mode status	56
RNG n	Set level range	56
UNT n	Set measurement mode	57
DET n	Set display characteristics	58
SNS n1 n2 n3 n4	Set sensitivity	58
LPF n	Set low-pass filter setting	59
HPF n	Set high-pass filter setting	60
CAL n	Set calibration mode	61
CAL?	Get calibration mode status	61
BAT?	Get battery capacity status	61
DOD?	Get measurement data	62
DOF n	Output instantaneous value every 0.1 seconds in non-protocol mode	63
MAX n	Set maximum hold function to On/Off	64
MAX?	Get maximum hold function status	64
PEK n	Set peak hold function to On/Off	64
PEK?	Get peak hold function status	64
RST	Reset hold value	65
CMP n	Set comparator function to On/Off	65
CMP?	Get comparator function status	65
CMS n1 n2 n3 n4 n5 n6 n7	Make comparator function settings	66
CMS?	Get comparator function settings	66
STS?	Get setting information	67

Note

Settings made via the serial interface are not memorized for the resume function (see page 20).

Commands

RMT n1 n2 n3	Select local mode/remote mode n1=0 Local mode n1=1 Remote mode n2 n3 = 00 to 15, FF Sets ID number. VM-83 specified by ID number receives the command. FF specifies all connected VM-83.
RMT?	Get ID number and remote mode status Output data format p1 p2 p3<EOT><CR><LF> p1, p2 is ID number p3=1 Remote mode
RNG n	Set level range Value of n is determined by INPUT SELECT switch setting, measurement mode, sensitivity information, and HPF setting, as shown in table below.

- When INPUT SELECT is set to PICKUP, PREAMP1, PREAMP2
(*0 = HPF 1 Hz, *1 = HPF 3 Hz, *2 = HPF 10 Hz and higher)

Sensitivity	Measurement mode	n=0	n=1	n=2	n=3	n=4	n=5	n=6	n=7
0.030 to 0.999 pC/(m/s ²)	ACC	3	10	30	100	300	1000	3000	10000
	VEL	30	100	300	1000	3000	10000	-	-
	DISP* ⁰	-	10	30	100	300	1000	3000	10000
	DISP* ¹	3	10	30	100	300	1000	3000	10000
	DISP* ²	0.3	1	3	10	30	100	300	1000
1.00 to 9.99 pC/(m/s ²)	ACC	0.3	1	3	10	30	100	300	1000
	VEL	3	10	30	100	300	1000	-	-
	DISP* ⁰	-	1	3	10	30	100	300	1000
	DISP* ¹	0.3	1	3	10	30	100	300	1000
	DISP* ²	0.03	0.1	0.3	1	3	10	30	100
10.0 to 99.9 pC/(m/s ²)	ACC	0.03	0.1	0.3	1	3	10	30	100
	VEL	0.3	1	3	10	30	100	-	-
	DISP* ⁰	-	0.1	0.3	1	3	10	30	100
	DISP* ¹	0.03	0.1	0.3	1	3	10	30	100
	DISP* ²	0.003	0.01	0.03	0.1	0.3	1	3	10

- When INPUT SELECT is set to SERVO ↓, SERVO ↔

Sensitivity	Measurement mode	n=1	n=2	n=3	n=4	n=5
0.100 to 0.999	ACC	10	30	100	300	1000
	VEL	1	3	10	30	100
	DISP	0.1	0.3	1	3	10

UNT n

Set measurement mode

n=0 ACC (acceleration)

n=1 VEL (velocity)

n=2 DISP (displacement)

DET n	Set display characteristics
	n=0 RMS
	n=1 EQPEAK
	n=2 EQP-P
SNS n1 n2 n3 n4	Set sensitivity
	n1 to n3 Set sensitivity to 030 to 999
	n4=0 Set sensitivity to 1/10 of value specified with n1 to n3
	n4=1 Set sensitivity to 1/100 of value specified with n1 to n3
	n4=2 Set sensitivity to 1/1000 of value specified with n1 to n3

Explanation for command SNS n1 n2 n3 n4

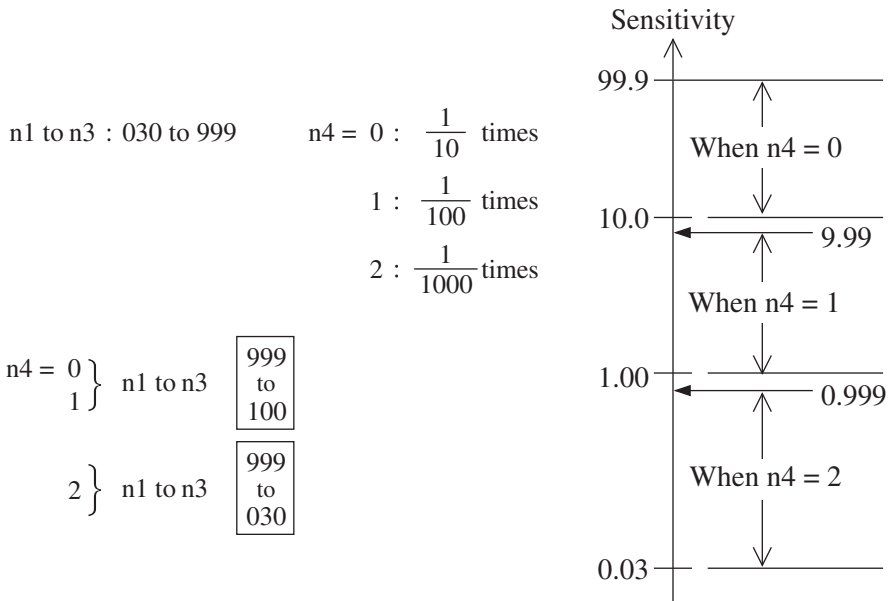

LPF n

Set low-pass filter setting

Command action depends on INPUT SELECT switch setting.

Piezoelectric accelerometer

PICKUP, PREAMP1, PREAMP2

Servo accelerometer

SERVO ↕, SERVO ↔

	Piezoelectric	Servo
n=0	100	50
n=1	300	100
n=2	1 k	100
n=3	3 k	100
n=4	10 k	100
n=5	OFF	100
n=6*	user filter	user filter

* This is valid only when the user filter is set up by using VM-83PB1 software (option).

HPF n

Set high-pass filter setting

Command action depends on INPUT SELECT switch setting.

Piezoelectric accelerometer

PICKUP, PREAMP1, PREAMP2

Servo accelerometer

SERVO ↓, SERVO ↔

	Piezoelectric	Servo
n=0	OFF	0.1
n=1	1	0.3
n=2	3	1
n=3	10	1
n=4	20	1
n=5	50	1
n=6*	user filter	user filter

* This is valid only when the user filter is set up by using VM-83PB1 software (option).

With piezoelectric accelerometer and measurement mode VEL or DISP, n = 0 setting is not allowed.

CAL n	Set calibration mode. n=0 Calibration OFF n=1 Calibration ON
CAL?	Get calibration mode status Output data format p<EOT><CR><LF> p=0 Calibration OFF p=1 Calibration ON
BAT?	Get battery capacity status Output corresponds to status of battery capacity indicator on display. Output data format p<EOT><CR><LF> p=0 Flashing p=1 1 segment lit p=2 2 segments lit p=3 3 segments lit

DOD?

Get measurement data

Returns a value corresponding to the display indication.

Output data format

p1 p2 p3 p4 E ± p5, p6 <EOT><CR><LF>

p1 to p4 Effective 4 digits of measurement value

p5=-6 to +1

p6=O (overload occurred)

p6= _ (no overload occurred) (_ is a space)

* Explanation of p5

p5 stands for 10^{p5} .

For example, when measurement value is 10000,

p5 will be 1, because 1000×10^1

* When operating in maximum hold mode, returned value corresponds to MAX HOLD value.

Same applies to peak hold mode.

When this command is received while there is no display indication, output will be p1 to p4=0000.

DOF n Output instantaneous value every 0.1 seconds in non-protocol mode

 n=0 Instantaneous value output OFF

 n=1 Instantaneous value output ON

Data will be output every 0.1 seconds. When DOF 0 is received, non-protocol mode output is terminated. For information on output data format, see section on “DOD?”.

DOF communication format

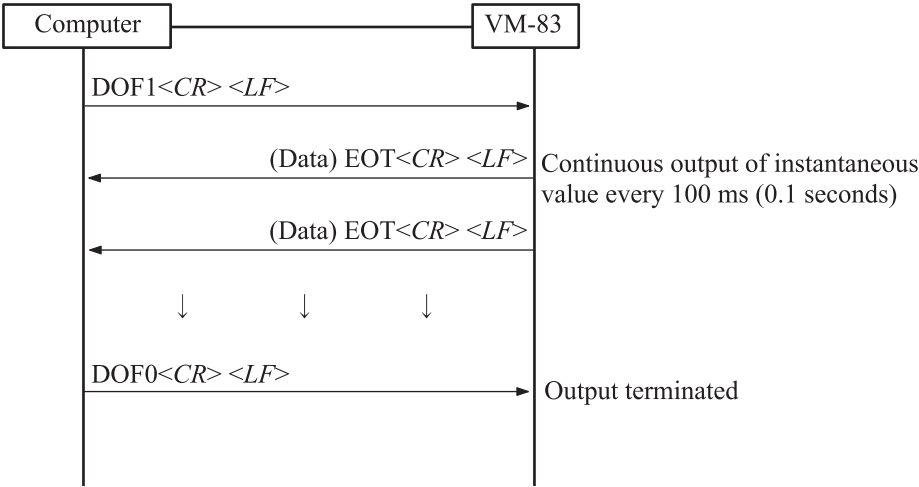

Note
Because this unit supports only half-duplex communication, it cannot receive and send data at the same time. When sending the DOF 0 command to the unit, the computer must use timing which ensures that the command does not collide with the instantaneous value data that are being output by the unit.

MAX n	Set maximum hold function to On/Off n=0 Maximum hold OFF n=1 Maximum hold ON
MAX?	Get maximum hold function status Output data format p<EOT><CR><LF> p=0 Maximum hold OFF p=1 Maximum hold ON
PEK n	Set peak hold function to On/Off n=0 Peak hold OFF n=1 Peak hold ON
PEK?	Get peak hold function status Output data format p<EOT><CR><LF> p=0 Peak hold OFF p=1 Peak hold ON

RST	Reset hold value This command is active during maximum hold, peak hold, and comparator operation.
CMP n	Set comparator function to On/Off n=0 Comparator OFF n=1 Comparator ON
CMP?	Get comparator function status Output data format p<EOT><CR><LF> p=0 Comparator OFF p=1 Comparator ON

CMS n1 n2 n3 n4 n5 n6 n7

Make comparator function settings

n1 to n2 Comparator level 00 to 98 (steps of 2)

n3 Delay time 0 to 9

n4=0 Auto reset OFF

n4=1 Auto reset ON

n5 to n6 Auto reset time 00 to 90 (steps of 10)

n7=0 Buzzer OFF

n7=1 Buzzer ON

For items that are not to be changed, send _ (space).

CMS?

Get comparator function settings

Output data format

p1 p2 p3 p4 p5 p6 p7<EOT><CR><LF>

p1 to p2 Comparator level 00 to 98

p3 0 to 9 (delay time)

p4 0 to 1 (auto reset ON/OFF)

p5 to p6 00 to 90 (auto reset time)

p7 0 to 1 (buzzer ON/OFF)

STS?

Get setting information

Output data format

p1 p2 p3 p4 p5 p6 p7 p8 p9 p10<EOT><CR><LF>

p1 INPUT SELECT 0 to 4

p1=0 PICKUP input

p1=1 PREAMP 1 input

p1=2 PREAMP 2 input

p1=3 SERVO ↓ input

p1=4 SERVO ↔ input

p2 Level range 0 to 7 (RNG n)

p3 Measurement mode 0 to 2 (UNT n)

p4 Display characteristics 0 to 2 (DET n)

p5 to p8 Sensitivity (SNS n1 n2 n3 n4)

p9 High-pass filter setting (HPF n)

p10 Low-pass filter setting (LPF n)

For information on value in brackets, refer to sections on respective commands.

Allowable remote mode commands in various operation conditions

○ indicates that command is allowed (valid).

× indicates that command is not allowed (invalid).

Command	Normal measurement	Calibration	Comparator	Maximum hold	Peak hold	DOF operation	Explanation
RMT n1n2n3	○	○	○	○	○	○	Cancel remote mode
RMT?	○	×	×	×	×	×	
RNG n	○	×	×	×	×	×	Level range
UNT n	○	×	×	×	×	×	Measurement mode
DET n	○	×	×	×	×	×	Display characteristics
SNS n1 to n4	○	×	×	×	×	×	Set sensitivity
LPF n	○	×	×	×	×	×	Low-pass filter
HPF n	○	×	×	×	×	×	High-pass filter
CAL n	○	○	×	×	×	×	Calibration setting
CAL?	○	○	×	×	×	×	
BAT?	○	×	×	×	×	×	Battery status
DOD?	○	×	○	○	○	×	Measurement value
DOF n	○	×	×	×	×	○ (DOF0)	Instantaneous value (100 ms)
MAX n	○	×	×	○ (MAX0)	×	×	Maximum hold
MAX?	○	×	×	○	×	×	
PEK n	○	×	×	×	○ (PEK0)	×	Peak hold
PEK?	○	×	×	×	○	×	
RST	×	×	○	○	○	×	Reset
CMP n	○	×	○ (CMP0)	×	×	×	Comparator
CMP?	○	×	○	×	×	×	
CMS n1 to n7	○	×	×	×	×	×	Comparator setting
CMS?	○	×	×	×	×	×	
STS?	○	×	×	×	×	×	Setting information

Technical Information

Noise level and measurement range

(1) Noise level using accelerometer input and sensitivity 5.00 pC/(m/s²)

Measurement mode	Measurement range	HPF	LPF	Display characteristics	Noise level
Acceleration	0.3	OFF	OFF	RMS	0.004 m/s ²
Velocity	3	1 Hz	OFF	RMS	0.1 mm/s
Displacement	1	1 Hz	OFF	RMS	0.015 mm
Displacement	0.03	10 Hz	OFF	RMS	0.0003 mm

(2) Noise level examples using piezoelectric accelerometer input

Accelerometer type	Measurement mode	Measurement range	HPF	LPF	Display characteristics	Noise level
PV-85	Acceleration	0.3	OFF	OFF	RMS	0.0034 m/s ²
	Velocity	3	10 Hz	OFF	RMS	0.004 mm/s
	Displacement	0.03	10 Hz	OFF	RMS	0.0002 mm
PV-90B	Acceleration	3	OFF	OFF	RMS	0.133 m/s ²
	Velocity	30	10 Hz	OFF	RMS	0.17 mm/s
	Displacement	0.3	10 Hz	OFF	RMS	0.007 mm
PV-87	Acceleration	0.03	OFF	OFF	RMS	0.0005 m/s ²
	Velocity	0.3	10 Hz	OFF	RMS	0.0006 mm/s
	Displacement	0.003	10 Hz	OFF	RMS	0.00003 mm*

* The LCD can display measurement values to four digits after the decimal point.

(3) Measurement range with servo accelerometer LS-10C

Acceleration measurement range

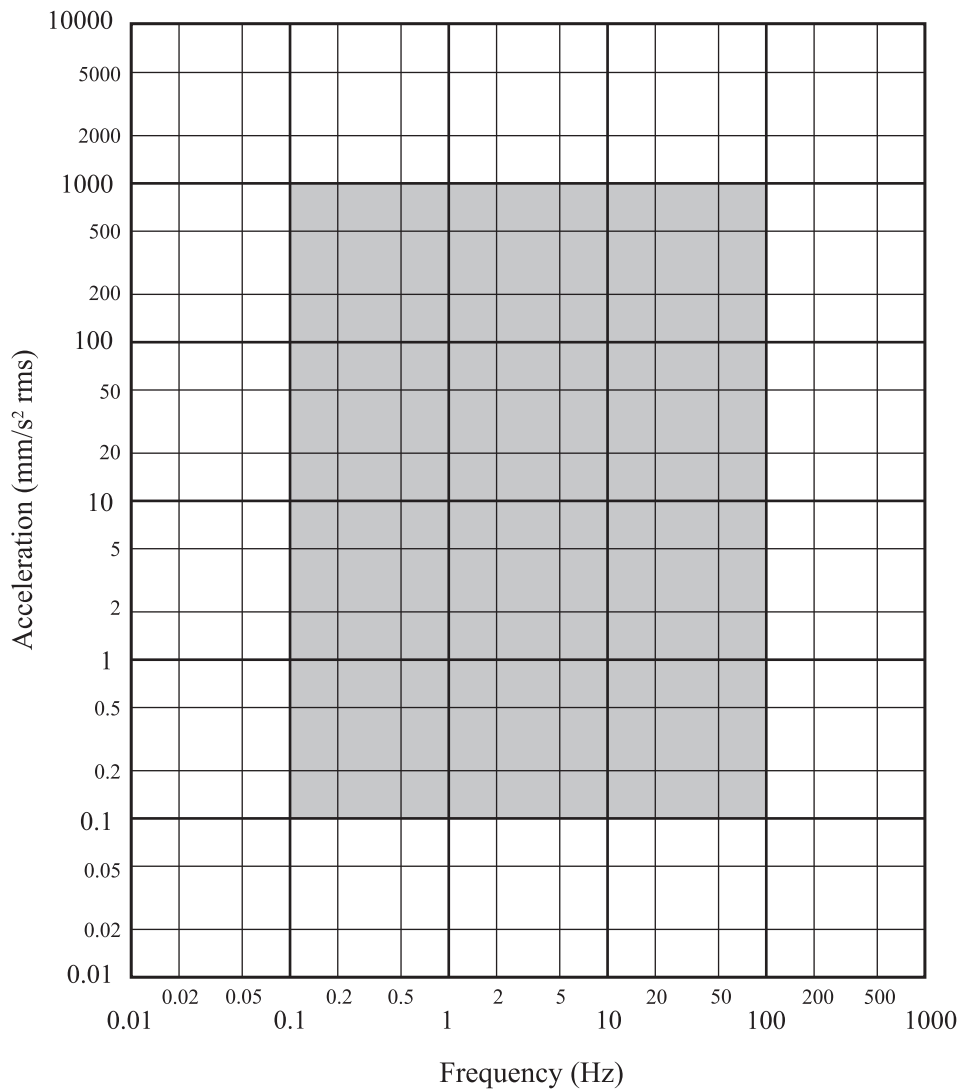

Velocity measurement range

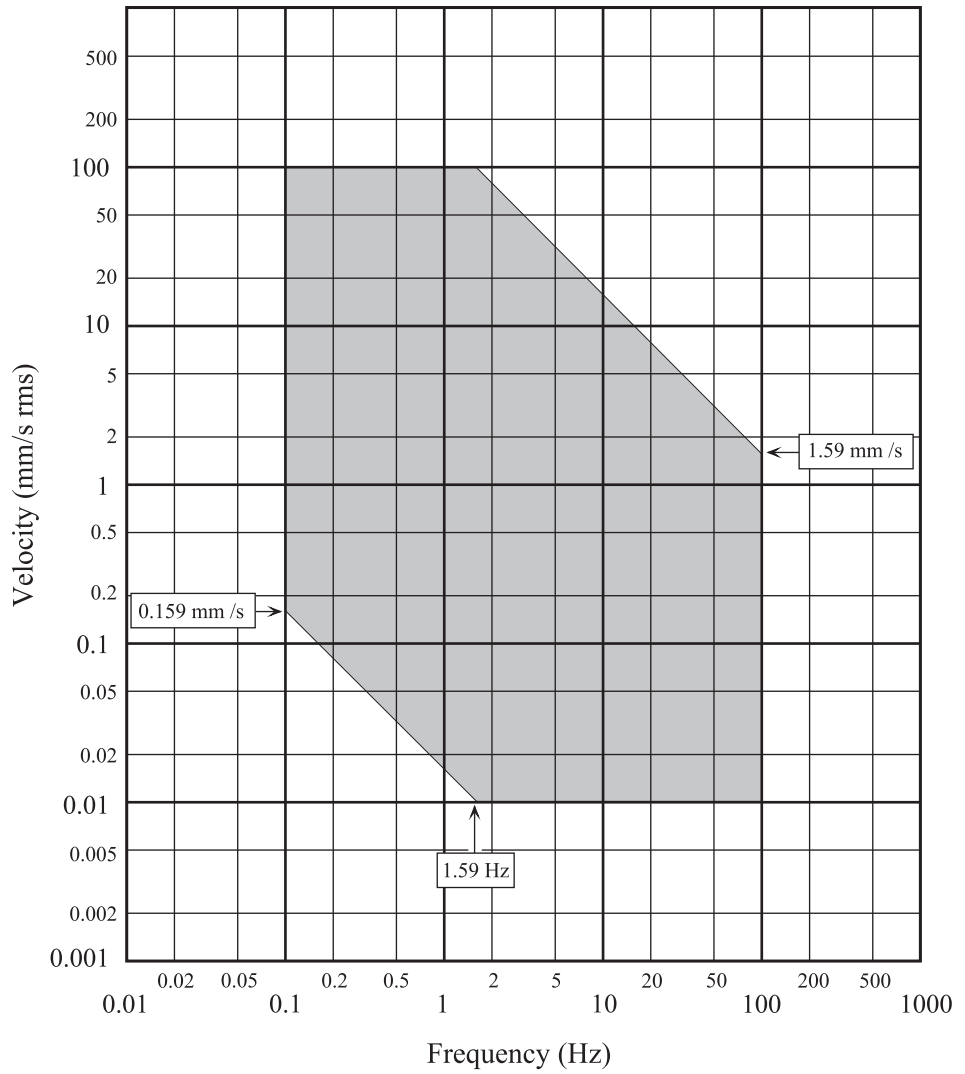

Displacement measurement range

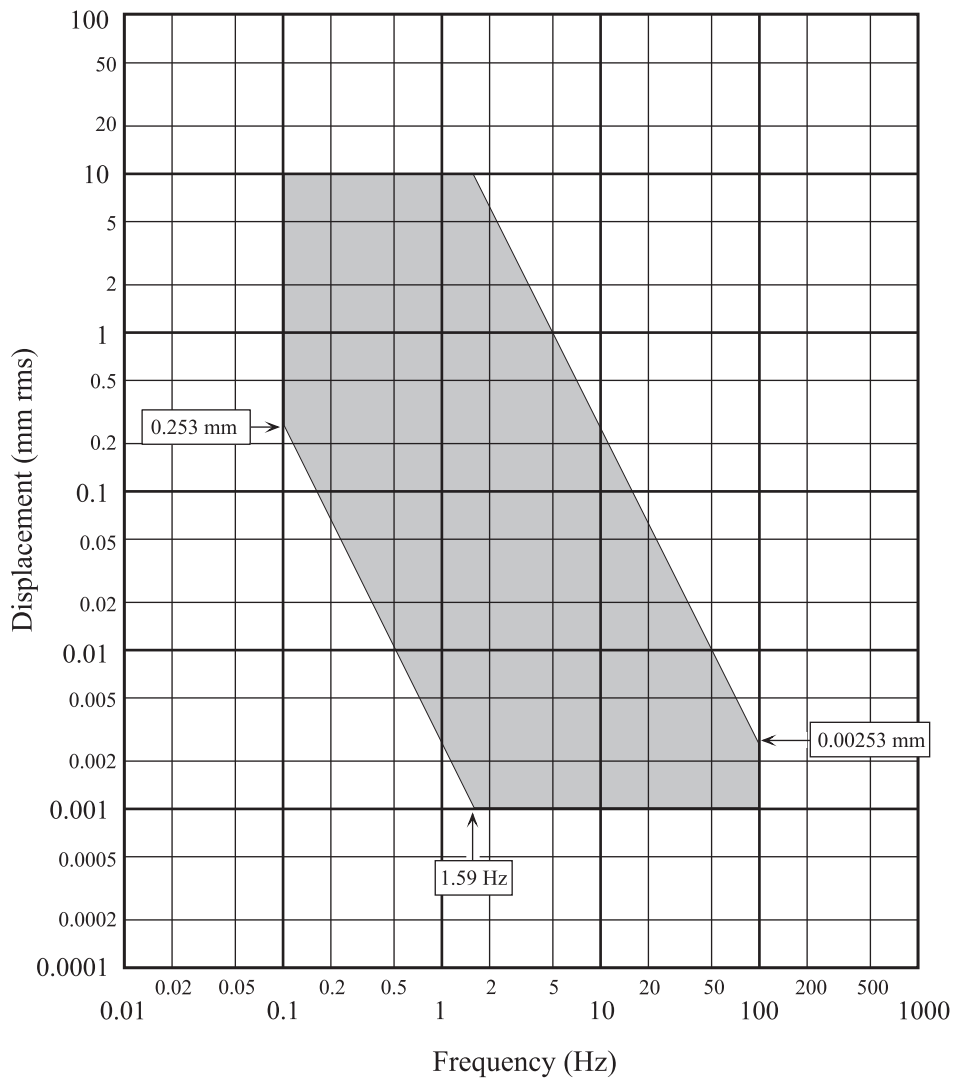

Delay of output signal

The VM-83 directly converts the vibration input signal from analog into digital form and performs signal processing in the digital domain, using a DSP. The signal is then reconverted to analog for the AC and DC output. For this reason, a certain delay is introduced as shown below.

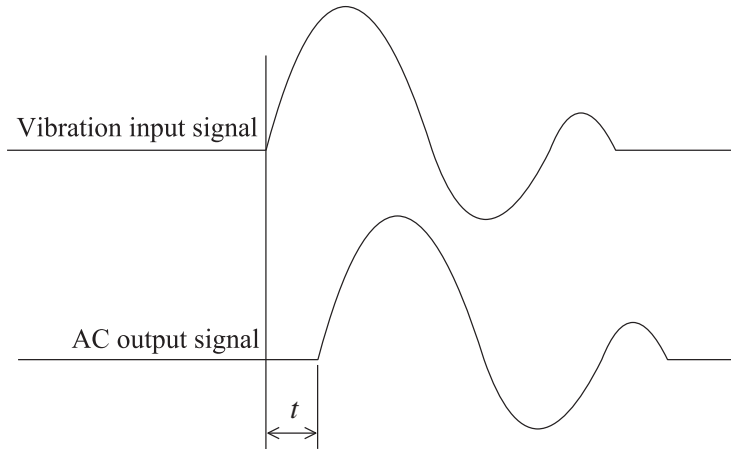

For products with the last four digits of the serial number between 0001 and 2363, t is approx. 600 μs

For products with the last four digits of the serial number since 2364, t is approx. 900 μs

Rack mounting

The VM-83 can be mounted in a rack, using the four screw holes on the bottom of the unit.

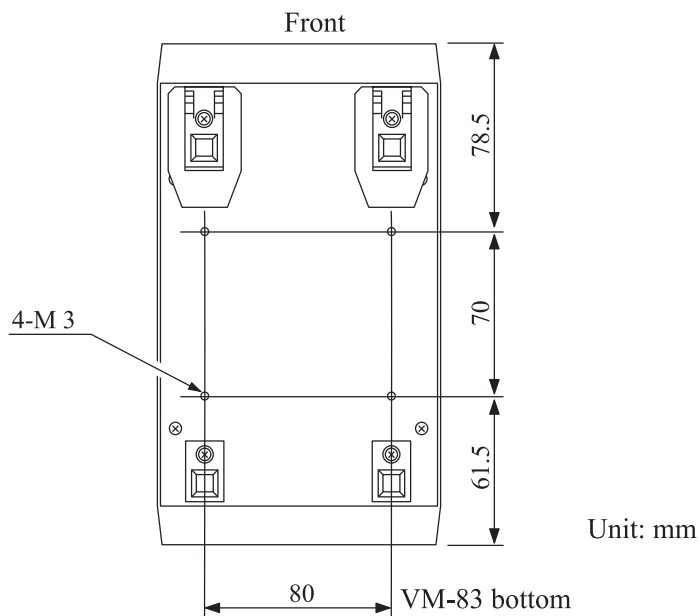

Accelerometer installation

The accelerometer can be mounted to the measurement object in one of the four general ways outlined below. The accelerometer mounting method greatly affects the contact resonance frequency *. The advantages and disadvantages of various methods are described in this section.

Rigid screw mounting

This mounting principle assures optimum frequency response characteristics. The mounting surface should be perfectly smooth, and the screw holes (M6) must be drilled in such a way so as not to disturb perpendicularity of the accelerometer.

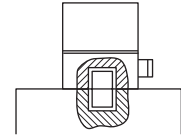

Insulation attachment mounting

This mounting principle is used when electrical insulation between accelerometer and measurement object is required. The contact resonance frequency will be lower than with rigid screw mounting. Regarding the screw holes, the same precautions as for rigid screw mounting apply.

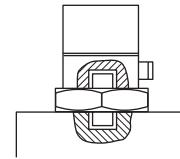

Magnet attachment mounting

Because the contact resonance frequency will be quite low, this principle is mainly suited for vibration measurements in the medium to low frequency range. The maximum acceleration that can be measured depends on the accelerometer mass.

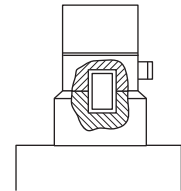

Rod attachment mounting

Pressing the accelerometer against the measurement object with a rod is the simplest method, but it is only suitable for measurements below 500 Hz, because contact resonance frequency will be very low. This method should only be used if the other three mounting methods are not feasible.

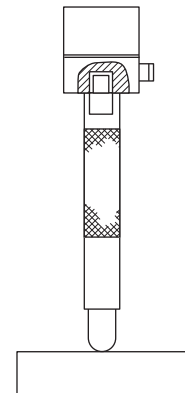

* Contact resonance frequency

Contact resonance occurs when the area where the mounted accelerometer contacts the measurement object becomes temporarily deformed, causing it to act like a spring. This spring and the accelerometer mass then form a system that vibrates at a certain resonance frequency.

The resonance frequency, which varies considerably depending on the mounting method of the accelerometer, limits the upper range of vibration frequencies that can be measured.

The diagram below shows the relationship between mounting method and high range characteristics. This demonstrates that, besides selecting an appropriate mounting method, it is important to set the measurement range so that the influence of the contact resonance phenomenon is excluded.

Sample chart showing the influence of accelerometer mounting method on high-range frequency characteristics

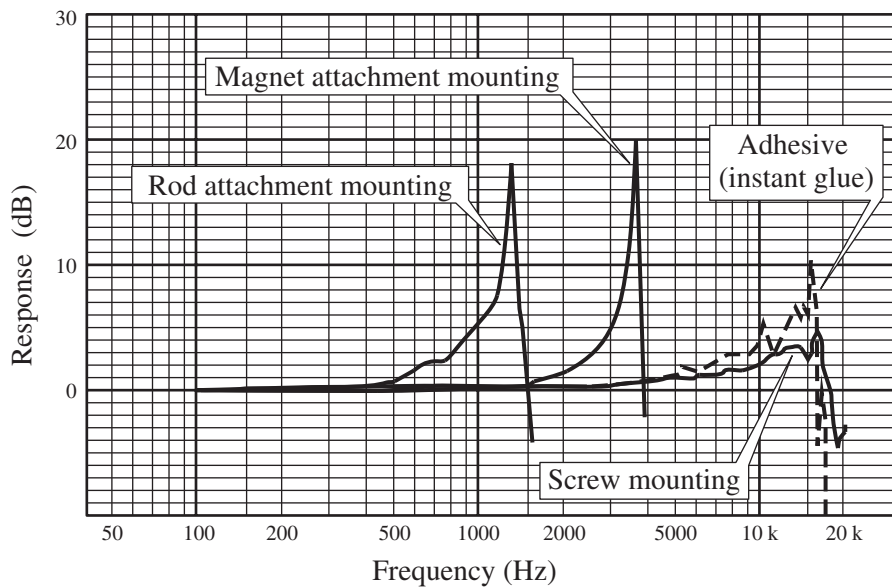

Display range

This section provides information on the numeric range of the digital display used in the VM-83.

For simplification, the range is assumed to be “100” and “30”, and the display characteristics setting EQ PEAK. Because the overload point of this unit is approximately three times the range full-scale point, the display range at the range “100” setting is about 300, and at the “30” setting (actually 31.6) is about 90, assuming that there is no overload in the intermediate circuits. The display resolution is 0.1 and 0.01. Therefore the possible display range is as follows:

Range	Display range
100	0.1 to 300.0
30	0.01 to 90.00

The VM-83 directly feeds the raw waveform of the vibration signal to an A/D converter and then performs filter processing, rms conversion, and other functions using a DSP. When the number of effective digits for display decreases, display accuracy cannot be maintained. Therefore the indication UNDER appears on the display when the displayed value falls below 0.5% of the full-scale point. This warns the user that the current range setting is not appropriate. To assure accurate readings, the range setting should be made so that the UNDER indication does not appear. At a level of 0.2% of the full-scale point and lower, the lowest bit level of the A/D converter is reached, so that readings will be indeterminate. At a range “30” setting, this corresponds to 0.06 and at a range “100” setting, this corresponds to 0.2. This means that readings below this limit will be highly imprecise, and that the display reading may not be 0 even if the actual vibration signal is very low.

Aliasing effect

The VM-83 directly converts the vibration input signal from analog into digital form and performs signal processing in the digital domain, using a DSP. This principle is subject to the so-called aliasing effect. An anti-aliasing filter (analog low-pass filter) serves to counter this effect. In the VM-83, a 5th-order filter is used for this purpose. Note that the filter has the effect shown below.

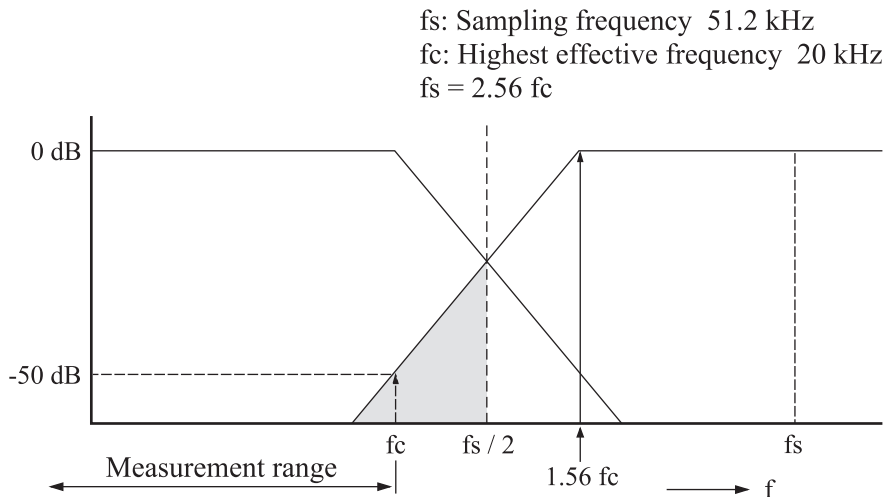

In the above illustration, the shaded section represents the area where the aliasing effect is noticeable. With $f_s/2$ as the center, the two spectrum representations look like mirror reflections of each other.

The arrow (solid line) indicates a case where a signal 1.56 times the 20 kHz upper measurement limit is input (31.2 kHz). In this case, aliasing will cause a spectrum level detection of -50 dB (0.3%) at 20 kHz.

Filter characteristics

Piezoelectric accelerometer

High-pass filter

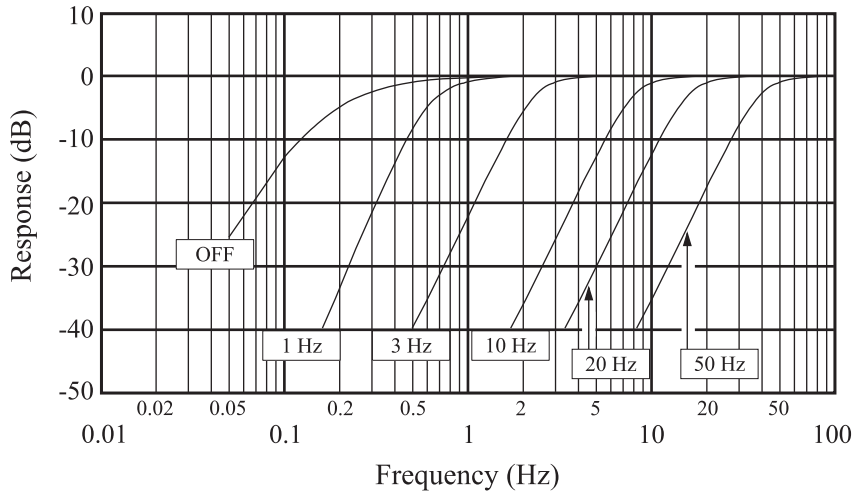

Low-pass filter

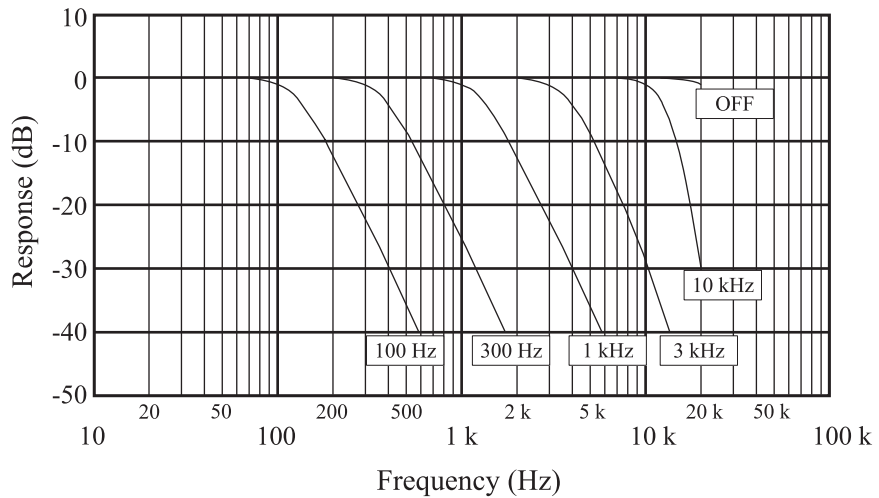

The above specifications are a representative example for AC output.

Servo accelerometer LS-10C

High-pass filter

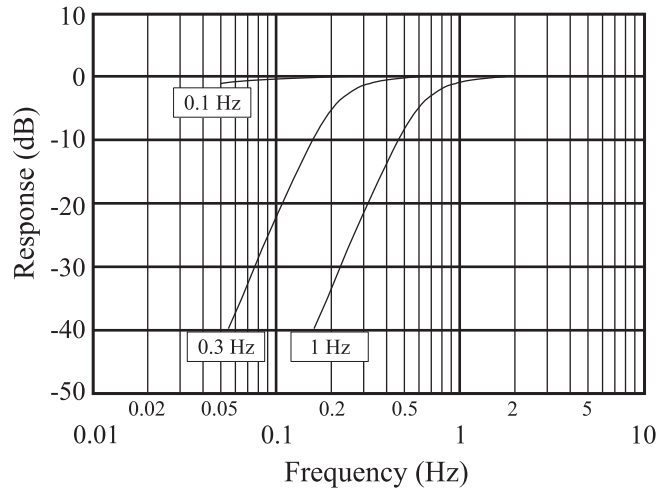

Low-pass filter

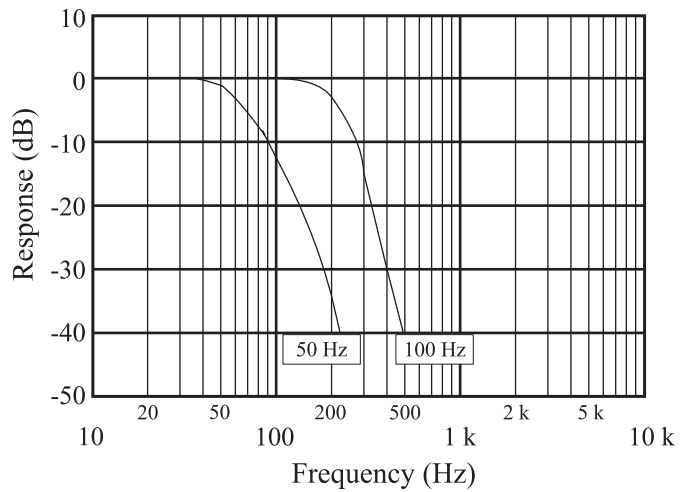

The above specifications are a representative example for AC output.

VM-83PB1 software

VM-83PB1 is a software package for Microsoft Windows 95, 98, 98SE, Me, 2000, XP and Microsoft Windows NT4.0 which allows controlling settings and measurement operation of the VM-83 from the computer, via the serial port. Measurement data downloaded from the VM-83 can be stored in text file format, allowing further processing for example using a spreadsheet program.

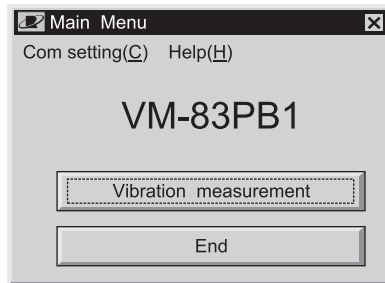

Menu screen

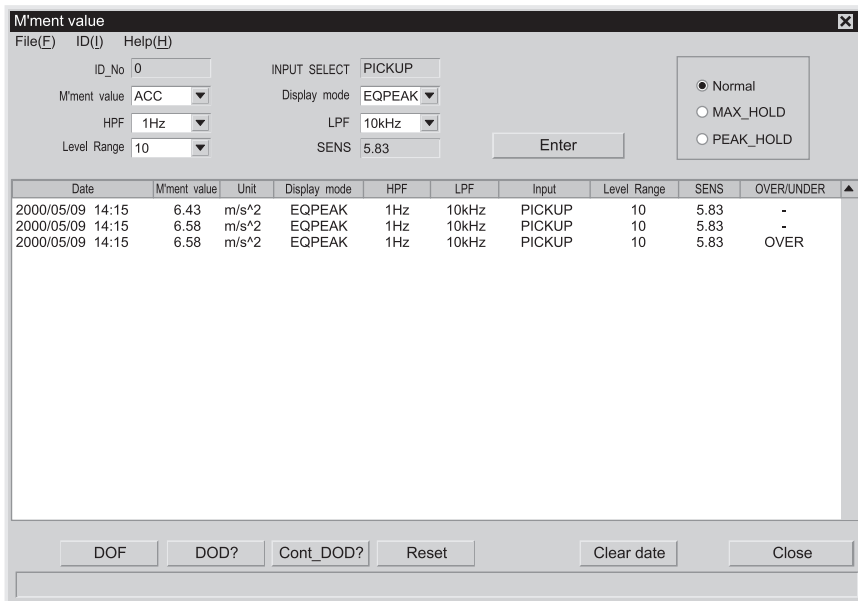

Vibration measurement screen (sample)

Microsoft and Windows are trademarks or registered trademark of Microsoft U.S.A. Corporation in the U.S.A. and other countries.

Specifications

Input Section

(1) PICKUP input

For piezoelectric accelerometer (microdot connector)
Maximum input charge 30000 pC

(2) PREAMP 1 input

For piezoelectric accelerometer via preamplifier VP-26A (7-pin female connector PRC-03)

(3) PREAMP 2 input

For piezoelectric accelerometer with integrated pre-amplifier
18 V, 2 mA drive (microdot connector)

(4) SERVO input

For servo accelerometer LS-10C or LS-20C
(8-pin female connector)

Measurement modes

(1) Acceleration (ACC)

m/s² (piezoelectric accelerometer), mm/s² (servo accelerometer)

(2) Velocity (VEL) mm/s

(3) Displacement (DISP)

mm

Measurement range

Piezoelectric accelerometer

- Accelerometer sensitivity 0.030 to 0.999 pC/(m/s²)

Acceleration 3, 10, 30, 100, 300, 1000, 3000, 10000 m/s²

Velocity 30, 100, 300, 1000, 3000, 10000 mm/s

Displacement 10, 30, 100, 300, 1000, 3000, 10000 mm (HPF 1 Hz)

Displacement 3, 10, 30, 100, 300, 1000, 3000, 10000 mm (HPF 3 Hz)

Displacement 0.3, 1, 3, 10, 30, 100, 300, 1000 mm

(HPF 10 Hz or higher)

- Accelerometer sensitivity 1.00 to 9.99 pC/(m/s²)
 - Acceleration 0.3, 1, 3, 10, 30, 100, 300, 1000 m/s²
 - Velocity 3, 10, 30, 100, 300, 1000 mm/s
 - Displacement 1, 3, 10, 30, 100, 300, 1000 mm (HPF 1 Hz)
 - Displacement 0.3, 1, 3, 10, 30, 100, 300, 1000 mm (HPF 3 Hz)
 - Displacement 0.03, 0.1, 0.3, 1, 3, 10, 30, 100 mm
(HPF 10 Hz or higher)
- Accelerometer sensitivity 10.0 to 99.9 pC/(m/s²)
 - Acceleration 0.03, 0.1, 0.3, 1, 3, 10, 30, 100 m/s²
 - Velocity 0.3, 1, 3, 10, 30, 100 mm/s
 - Displacement 0.1, 0.3, 1, 3, 10, 30, 100 mm (HPF 1 Hz)
 - Displacement 0.03, 0.1, 0.3, 1, 3, 10, 30, 100 mm (HPF 3 Hz)
 - Displacement 0.003, 0.01, 0.03, 0.1, 0.3, 1, 3, 10 mm
(HPF 10 Hz or higher)

Servo accelerometer

- Acceleration 10, 30, 100, 300, 1000 mm/s²
- Velocity 1, 3, 10, 30, 100 mm/s
- Displacement 0.1, 0.3, 1, 3, 10 mm

Vibration frequency range

Piezoelectric accelerometer

- Acceleration 1 Hz to 20 kHz $\pm 5\%$
(AC output: 15 kHz to 20 kHz $\begin{matrix} +5\% \\ -15\% \end{matrix}$)
- Velocity 1 Hz to 3 Hz $\pm 10\%$, 3 Hz to 3 kHz $\pm 5\%$
- Displacement 1 Hz to 3 Hz $\pm 20\%$, 3 Hz to 500 Hz $\pm 10\%$

Servo accelerometer

- Acceleration 0.1 Hz to 100 Hz $\pm 5\%$
- Velocity 0.1 Hz to 0.3 Hz $\pm 10\%$, 0.3 Hz to 100 Hz $\pm 5\%$
- Displacement 0.1 Hz to 0.3 Hz $\pm 20\%$, 0.3 Hz to 100 Hz $\pm 10\%$

Filters

Piezoelectric accelerometer

HPF OFF, 1, 3, 10, 20, 50 Hz (-10% point), selectable

LPF OFF, 100, 300, 1 k, 3 k, 10 kHz (-10% point), selectable

Servo accelerometer

HPF 0.1, 0.3, 1 Hz, selectable

LPF 50, 100 Hz, selectable

Display (detection) characteristics

Effective value (RMS)

True rms

Equivalent peak value (EQPEAK)

$\text{rms} \times \sqrt{2}$

Equivalent peak-to-peak value (EQP-P)

$\text{EQPEAK} \times 2$

Maximum value hold Maximum display value for selected measurement mode and display characteristics is held (numeric display only). Hold reset key allows reset at any time.

Peak value hold Peak value of acceleration waveform is held.

Comparator function Level evaluation based comparator. Output activated when comparator level is exceeded

- Comparator level setting

In 2% steps of full-scale value

- Delay time 0 s to 9 s in 1-s steps

- Auto reset time 0 s to 90 s in 1-s steps, ON/OFF

- Comparator output

Open-collector output

Max. applied voltage: 24 V

Max. drive current:

50 mA (when the applied voltage is 24 V)

25 mA (when the applied voltage is 12 V)

10 mA (when the applied voltage is 5 V)

Buzzer output ON/OFF; LCD flashing

Outputs

- (1) AC output Range full-scale 2 V, output impedance 600 Ω , BNC connector
 Load impedance 10 k Ω or higher
 Output voltage accuracy
 Piezoelectric (unit electrical characteristics, 80 Hz)
 Acceleration range full-scale $\pm 2\%$
 Velocity range full-scale $\pm 3\%$
 Displacement range full-scale $\pm 5\%$
 Servo accelerometer
 (overall accuracy with LS-10C 1 Hz)
 Acceleration range full-scale $\pm 3\%$
 Velocity range full-scale $\pm 4\%$
 Displacement range full-scale $\pm 6\%$
 Max. output voltage ± 6 V peak
- (2) DC output Range full-scale 2 V, output impedance 600 Ω , BNC connector
 Load impedance 10 k Ω or higher
 Output voltage accuracy
 Piezoelectric (unit electrical characteristics, 80 Hz)
 Acceleration range full-scale $\pm 2\%$
 Velocity range full-scale $\pm 3\%$
 Displacement range full-scale $\pm 5\%$
 Max. output voltage 6 V (4.2 V when rms display is selected)
- (3) Comparator output
 Open collector

Noise level

(1) Noise level with accelerometer input, sensitivity 5.00 pC/(m/s²)

Measurement mode	Measurement range	HPF	LPF	Display characteristics	Noise level
Acceleration	0.3	OFF	OFF	RMS	0.004 m/s ²
Velocity	3	1 Hz	OFF	RMS	0.1 mm/s
Displacement	1	1 Hz	OFF	RMS	0.015 mm
Displacement	0.03	10 Hz	OFF	RMS	0.0003 mm

(2) Noise level examples using piezoelectric accelerometer input

Accelerometer type	Measurement mode	Measurement range	HPF	LPF	Display characteristics	Noise level
PV-85	Acceleration	0.3	OFF	OFF	RMS	0.0034 m/s ²
	Velocity	3	10 Hz	OFF	RMS	0.004 mm/s
	Displacement	0.03	10 Hz	OFF	RMS	0.0002 mm
PV-90B	Acceleration	3	OFF	OFF	RMS	0.133 m/s ²
	Velocity	30	10 Hz	OFF	RMS	0.17 mm/s
	Displacement	0.3	10 Hz	OFF	RMS	0.007 mm
PV-87	Acceleration	0.03	OFF	OFF	RMS	0.0005 m/s ²
	Velocity	0.3	10 Hz	OFF	RMS	0.0006 mm/s
	Displacement	0.003	10 Hz	OFF	RMS	0.00003 mm*

* The LCD can display measurement values to four digits after the decimal point.

(3) Measurement range with servo accelerometer LS-10C

Acceleration measurement range

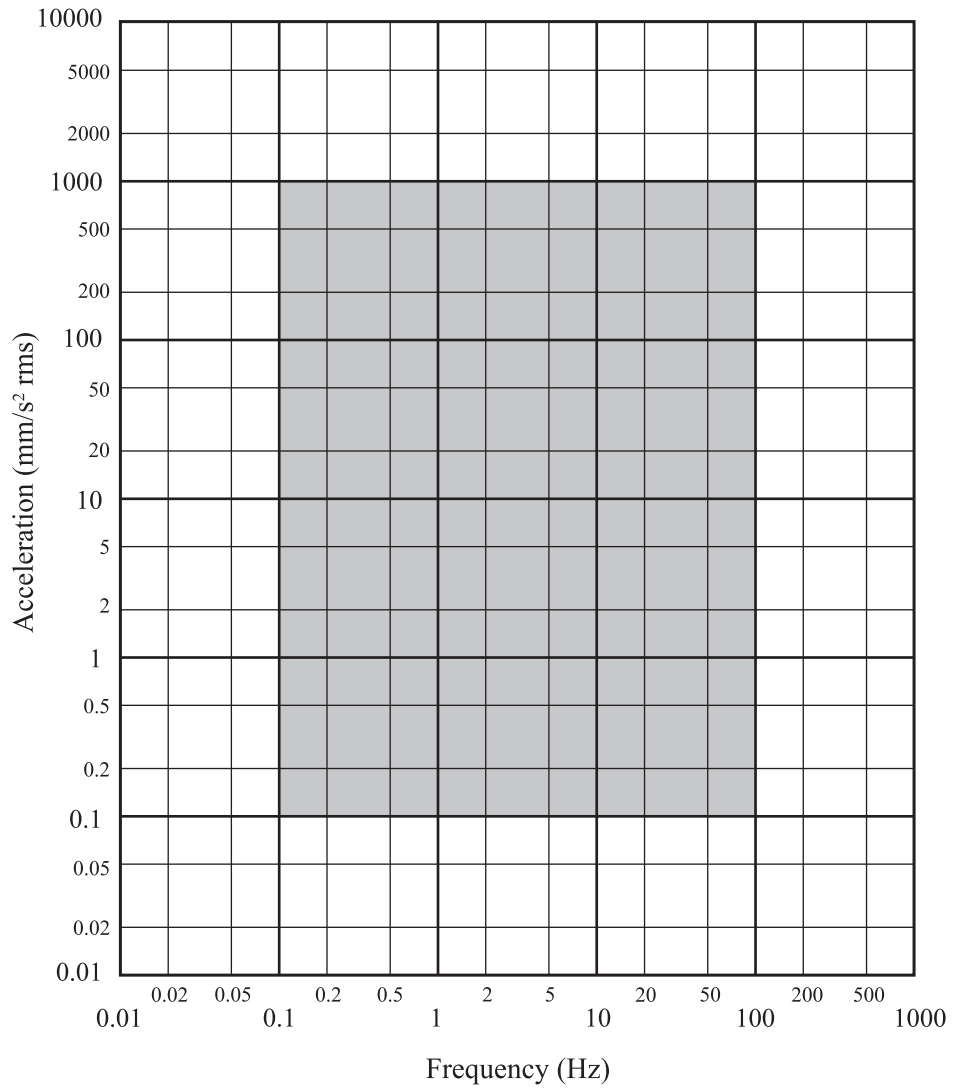

Velocity measurement range

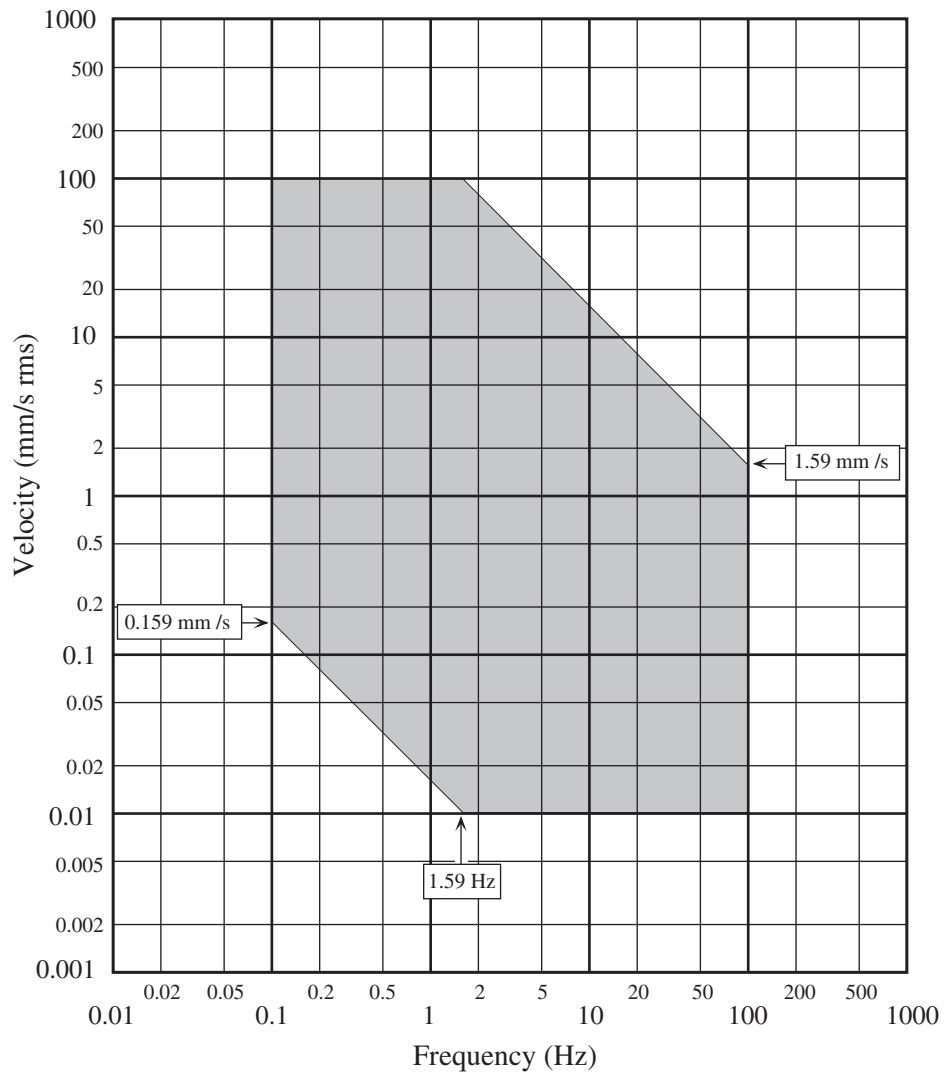

Displacement measurement range

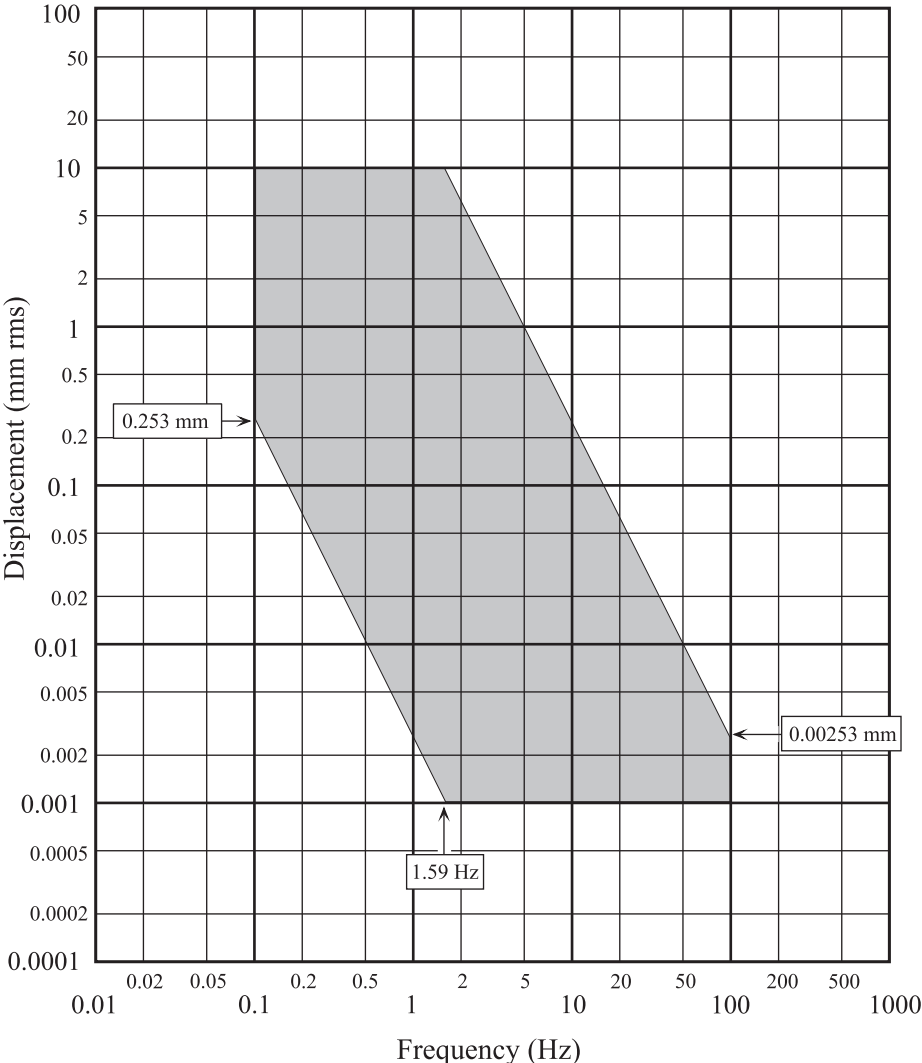

Interface

Serial interface For data output and remote control
9-pin D-sub male connector
Half-duplex communication with protocol
Transfer rate 9600, 19200 bps

Printer output For data output to printer (CP-10, CP-11, DPU-414)

Ambient conditions for operation

-10 to +50°C, 20 to 90% RH (no condensation)

Power requirements IEC R14 (size C) batteries (×4) or optional AC adapter
NC-98C

Input voltage range of external power supply connector

5 V to 6.5 V DC

Current consumption

Approx. 190 mA (6 V DC) (*1)

Approx. 60 mA (using AC adapter) (*1, *2)

Battery life for continuous operation

Alkaline batteries (approx. 20 hours) (*1)

Manganese batteries (approx. 9 hours) (*1)

*1 Measurement conditions:

20°C, 50% RH, power supply voltage 6 V, Accelerometer input, ACC, backlight off, communication off, switch LEDs off

*2 Measurement conditions:

Current consumption measured with AC adapter at 100 V AC.

Dimensions 171 mm (H) × 120 mm (W) × 234 mm (D)

Weight Approx. 1.8 kg

Supplied Accessories

Carrying case	1
IEC R14 (size C) batteries	4
Instruction manual	1
Inspection Certificate	1

Optional Accessories

AC adapter	NC-98C (100 to 240 V)
Piezoelectric accelerometer	
Vibration meter preamplifier	VP-26A
Extension cable	EC-02S series
Servo accelerometer	LS-10C, LS-20C
Servo accelerometer cable	EC-40 series
Calibrator	VE-10, VE-20
VM-83 management software	VM-83PB1 (for Windows 95, 98, 98SE, Me, 2000, XP and Windows NT4.0)
Printer	DPU-414
Printer cable	Generic straight-wired serial cable
Interface cable	Generic cross-wired serial cable

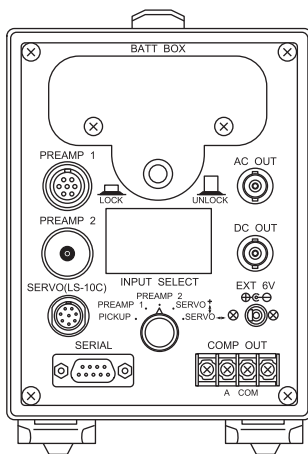
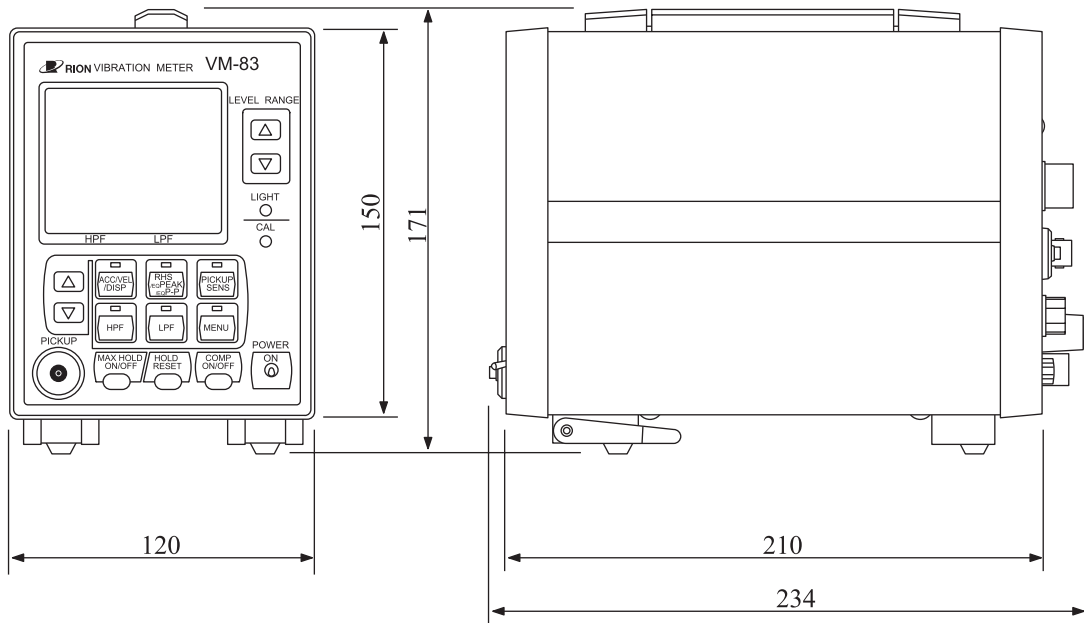

Unit: mm

Dimensional drawings

Index

A

AC adapter ----- 5, 12
Acceleration measurement range
----- 70, 87
Accelerometer ----- 14, 74
Accelerometer input connector ----- 4
Accelerometer sensitivity calibration
----- 18
Accelerometer sensitivity key ----- 3
AC output connector ----- 5
Aliasing effect ----- 77
Ambient conditions for operation --- 90
Auto reset function ----- 40
Auto reset time ----- 40

B

Bar graph ----- 9, 39
BAT? ----- 55, 61
battery capacity ----- 12, 55
Battery capacity indicator ----- 10
Battery holder ----- 5, 11
Battery holder button ----- 5, 11
Battery life ----- 12
Buzzer ----- 40

C

CAL? ----- 55, 61
Calibration ----- 31, 84
Calibration key ----- 3
calibration mode ----- 55
CAL indicator ----- 10
CAL n ----- 55, 61
CMP? ----- 55, 65
CMP n ----- 55, 65

CMS? ----- 55, 66
CMS n1 n2 n3 n4 n5 n6 n7 ----- 55, 66
Comparator function ----- 55, 83
Comparator operation ----- 38
Comparator output ----- 42
Comparator output terminals -- 5, 6, 42
COMP indicator ----- 8
COMP ON/OFF key ----- 4
Contact resonance frequency ----- 75

D

DC output connector ----- 5
DET n ----- 55, 58
Dimensional drawings ----- 92
Dimensions ----- 90
DIP switch ----- 44
Displacement measurement range
----- 72, 89
Display ----- 4
Display backlight key ----- 3
display characteristics ----- 55
Display characteristics ----- 22
Display characteristics selector key -- 4
Display (detection) characteristics
----- 4, 83
Display functions ----- 84
Display range ----- 76
DOD? ----- 55, 62
DOF n ----- 55, 63

- E**
- Equivalent peak----- 22, 83
 - Equivalent peak-to-peak----- 22, 83
 - Error processing -----52
 - External power supply connector 5, 12
- F**
- Feet----- 7
 - Filter characteristics-----78
 - Filters -----83
- G**
- Grip----- 7
- H**
- High-pass filter ----- 4, 23, 23
 - High-pass filter indicator----- 9
 - High-pass filter key ----- 4
 - HOLD RESET key----- 4
 - HPF n ----- 55, 60
- I**
- Input select switch ----- 6
 - INPUT SELECT switch----- 17
 - instantaneous value -----55
- L**
- Level range ----- 25, 55
 - Level range indicator ----- 10
 - LEVEL RANGE keys ----- 3
 - Local mode----- 48, 55
 - Low-pass filter----- 4, 24, 55
 - Low-pass filter indicator ----- 9
 - Low-pass filter key ----- 4
 - LPF n----- 55, 59
- M**
- MAX?----- 55, 64
 - MAX HOLD ON/OFF key ----- 4
 - maximum hold function -----55
 - Maximum value hold ----- 33, 83
 - maximum value hold function----- 4
 - MAX n----- 55, 64
 - measurement data -----62
 - Measurement mode -----21, 57, 81
 - Measurement mode selector key ----- 4
 - Measurement range -----81
 - Measurement value ----- 9
 - MENU key ----- 4
 - Menu settings -----27
- N**
- Noise level----- 69, 86
- O**
- Outputs-----85
 - OVER indicator----- 8
- P**
- Parameters-----54
 - Peak hold -----36
 - peak hold function -----55
 - PEAK/MAX HOLD/OVER indicators ----- 9
 - Peak value hold-----83
 - PEK?----- 55, 64
 - PEK n ----- 55, 64
 - PICKUP input -----81
 - Piezoelectric accelerometer ---- 14, 15
 - Power requirements -----90
 - Power switch----- 4
 - PREAMP 1 input-----81
 - PREAMP 2 input-----81

- preamplifier ----- 15
 Preamplifier 1 input connector ----- 6
 Preamplifier 2 input connector ----- 6
 Printer ----- 43
 Printer output ----- 90
 Printout sample ----- 46
 prop-up feet ----- 7, 13
- R**
- Rack ----- 73
 Remaining battery capacity indication
 ----- 12
 REMOTE indicator ----- 8
 Remote mode ----- 48, 55
 Reset hold value ----- 55
 resume function ----- 20
 RMS/EQPEAK/EQP-P indicators ----- 9
 RMT? ----- 55, 56
 RMT n1 n2 n3 ----- 55, 56
 RNG n ----- 55, 56
 RST ----- 55, 65
- S**
- Sending of commands ----- 50
 sensitivity ----- 55
 Serial interface ----- 47, 90
 Serial interface connector ----- 6
 Servo accelerometer ----- 14, 16, 79
 SERVO input ----- 81
 Servo input connector ----- 6
 setting information ----- 55
 Setting keys ----- 4
 SNS n1 n2 n3 n4 ----- 55, 58
 STS? ----- 55, 67
- U**
- UNDER indicator ----- 10
 Units indicator ----- 9
 UNT n ----- 55, 57
- V**
- Velocity measurement range ---- 71, 88
 Vibration frequency range ----- 82
 VM-83PB1 ----- 80
- W**
- Weight ----- 90

